

University of Piraeus
Department of Digital Systems
MSc Digital Communications and Networks

Master Thesis

**«Wi-Fi Evolution: The IEEE 802.11ax standard for
dense wireless local area networks»**



Full name: Gotsis Theodoros

Professor: Alexiou Aggeliki

Piraeus 2017

Acknowledgements

For the preparation of this Thesis I would like to thank Mrs. Angeliki Alexiou Associate Professor of the Department of Digital Systems, University of Piraeus, who with perseverance, patience, knowledge and experience offered valuable assistance and contributed greatly. Furthermore, I would like to thank her for the excellent communication we had and the immediate response to solving my queries.

Abstract

The journey from IEEE 802.11n to IEEE 802.11ac standard contained many technological advances of the standards for Wireless Local Area Networks (WLANs). The transition to the 5 GHz band in IEEE 802.11ac led to the use of non-adjacent channels for increasing transmission bandwidth to 160 MHz. The modulation schemes that are employed achieved a further increase of the data rate in the order of 6.9 Gbps. In 2014 the IEEE 802.11ax Working Group was established for the purpose of creating a modification of IEEE 802.11ac that will operate in dense wireless LANs. The new model will use many of the features of IEEE 802.11ac but will also include many new features and enhancements. The aim is to support simultaneous transmissions and reduce the interference in dense WLAN environments. From the literature, it is apparent that the Orthogonal Frequency-Division Multiple Access (OFDMA) is a basic technology to be used in IEEE 802.11ax standard. Moreover, the management of multiple Overlapping Basic Service Sets (OBSSs) through the dynamic adjustment of the Clear Channel Assessment (CCA) threshold for minimizing the interference is an important parameter studied by the IEEE 802.11ax Working Group. The optimal setting of CCA is an important feature for enhancing spatial reuse. The Working Group has already performed studies and proposed the introduction of two CCA thresholds for OBSSs environments.

TABLE OF CONTENTS

List of figures	5
List of tables.....	7
Glossary.....	8
List of Acronyms	8
Outline of thesis	12
Introduction	13
1. Developments in the IEEE 802.11n IEEE 802.11ac and ax.....	16
2. Evolution 802.11ac, 802.11ax.....	23
3. MAC Mechanisms for High Efficiency	27
3.1 Spatial Reuse.....	27
3.2. Power-saving with Target Wake Time	29
3.3. Clear Channel Assessment (CCA).....	30
Fixed CCA Enhancements:.....	34
Dynamic CCA Enhancements:	34
4. PHY Mechanisms for High Efficiency.....	42
4.1. Beamforming	42
4.2. Multi-User MIMO	44
4.3. Orthogonal Frequency Division Multiple Access (OFDMA).	47
5. Performance Evaluation 802.11ac/ax	51
5.1 Modifications to the WLAN standard have been studied to PHY layer.....	51
5.2 PRECODING ALGORITHMS.....	56
5.1. Intro to Simulations	58
5.1.1 Simulation Parameters and Configuration	60
5.1.2 Scenario 1	62
5.1.3 Scenario 2.....	67
5.1.4 Scenario 3.....	71
References	80
Appendix A	84

List of figures

Figure 0: Wi-Fi technology evolution

Figure 1: Mandatory and optional features of the IEEE 802.11ac

Figure 2: Comparison of Single-User and Multi-User MIMO

Figure 3: Improved spatial reuse with MU-MIMO

Figure 4: A-MPDU aggregation for better performance

Figure 5: A-MSDU encapsulation

Figure 6: A-MSDU encapsulation 2

Figure 7: Clear Channel Assessment Protocol

Figure 8: Medium Access inefficiency from overlapping BSS

Figure 9: Example 802.11ax channel allocation on the 5GHz band

Figure 10: Narrower sub-carrier spacing

Figure 11: Beamforming basics

Figure 12: Beamforming Range effects

Figure 12a: MIMO channel model with N_t transmit antennas, N_r receive antennas, and channel gain h_{ij} between the i^{th} transmit antenna and the j^{th} receive antenna.

Figure 13: A beamformer (AP) requesting channel information for MU-MIMO operation

Figure 14: A single user using the channel VS. multiplexing various users in the same channel using OFDMA

Figure 15: Subdividing Wi-Fi channels using various Resource Unit sizes

Figure 16: Framework based on OFDMA MAC protocol

Figure 17: A beamformer (AP) requesting channel information for MU-MIMO operation

Figure 18: Example of MU PPDU exchange and NAV setting

Figure 19: Example of Target Wake Time Broadcast operation

Figure 20: Illustration of concurrent and interfering STA-to-AP transmissions

Figure 21: Primary and secondary channel nomenclature

Figure 22: Coexistence of multiple networks in the same frequency space

Figure 23: Overlapping BSS scenario

List of tables

Table 1: Basic technological parameters for 802.11ac and IEEE standards 802.11ax

Table 2: Classification of potential HEW spatial reuse schemes

Table 3: CCA levels defined in [12]

Table 4: Primary and secondary channel relationship in Figure21

Table 5: CCA sensitivity thresholds

Glossary

List of Acronyms

A-MPDU Aggregated MPDU

A-MSDU Aggregated MSDU

ACK Acknowledgment

AP Access Point

BER Bit Error Rate

BPSK Binary Phase Shift Keying

BSS Basic Service Set

BSSID BSS Identifier

CCA Clear Channel Assessment

CCA-CS CCA carrier sensing

CCA-ED CCA energy detection

CCAT CCA Threshold

CDMA Code Division Multiple Access

CS Carrier Sense

CSI Channel State Information

CSMA/CA Carrier Sense Multiple Access with Collision Avoidance

CSMA/CD Carrier Sense Multiple Access with Collision Detection

CSMA Carrier Sense Multiple Access

CTS Clear To Send

CSI Channel State Information

CW Contention Window

DA destination address

DL Down Link

DIFS Distributed Interframe Space

DSC Dynamic Sensitivity Control

EDCA Enhanced Distributed Channel Access

ESS Extended Service Set

FCS Frame Check Sequence

FDMA Frequency Division Multiple Access

FER Frame Error Rate

FFT Fast Fourier Transform

HEW High Efficiency WLAN

HT High Throughput

IBSS Independent BSS

IEEE Institute of Electrical and Electronics Engineers

LAN Local Area Network

LLC Logical Link Control

LTE Long-Term Evolution

MAC Media Access Control Layer

MIMO Multiple-Input Multiple-Output

MIMO-BC MIMO Broadcast Channel

MIMO-MAC MIMO Medium Access Control

MPDU MAC Protocol Data Unit

MSDU MAC Service Data Unit

MU-MIMO Multi-User MIMO

MLP Multi-Layer Perception

NAV Network Allocation Vector

OBSS Overlapping BSS

OFDM Orthogonal Frequency Division Multiplexing

OFDMA Orthogonal Frequency Division Multiple Access

P2P Peer-to-Peer

PCS Physical Carrier Sensing

PCSA Physical Carrier Sensing Adaptation

PDU Protocol Data Unit

PER Packet Error Rate

PHY Physical Layer

PLCP Physical Layer Convergence Protocol

PPDU Physical Protocol Data Unit

PSDU Physical Service Data Unit

QAM Quadrature Amplitude Modulation

QoS Quality of Service

RTS Request To Send

SA source address

SISO Single Input Single Output

SNR Signal to Noise Ratio

SR Spatial Reuse

SSID Service Set Identifier

STA Station

STBC Space time Block Coding

TDMA Time Division Multiple Access

TG Task Group

TPC Transmit Power Control

TXOP Transmit Opportunity

UDP User Datagram Protocol

UL Uplink

VCS Virtual Carrier Sensing

VHT Very High Throughput

WG Working Group

WLAN Wireless Local Area Network

Outline of thesis

The path from IEEE 802.11n to IEEE 802.11ac contained many technological advances in wireless local area network standards. The transition to the 5 GHz band in IEEE 802.11ac led to the use of non-adjacent channels by increasing the available bandwidth that can be used to transmit up to 160 MHz. The formatting techniques used achieve data transmission rates of 6.9 Gbps. In 2014, the IEEE 802.11ax Working Group was set up to create a modification of the IEEE 802.11ac with primary use in very dense wireless local area networks. The new standard is expected to use many of the features of the IEEE 802.11ac, but also includes many new mechanisms and features. The goal is to achieve high throughput in multiple transmissions and reduce interference in dense environments. The working group has already proposed the introduction of the MU MIMO technology, which will help to achieve this goal. The simulations performed in the Matlab environment studied the behavior of dense wireless local area networks according to the parameter values such as SNR, number of users, number of antennas and number of spatial streams.

Introduction

Wi-Fi (Wireless Fidelity) is a popular wireless LAN technology. It provides broadband wireless connectivity to fixed, portable and moving users in the unlicensed and 2.4/5 GHz frequency bands. The Wi-Fi technology is rapidly gaining acceptance as an alternative to a wired local area network since it is much easier and more cost-efficient to deploy. Wireless access to data has become an everyday necessity for both consumers' enterprises. In the last 30 years alone, unfettered access to information has transformed entire industries, fueling growth, productivity and profits.

Wi-Fi technology, governed by the IEEE 802.11 standards body, has played a key role in this transformation, providing users with pervasive, low cost access to high data rate wireless connectivity.

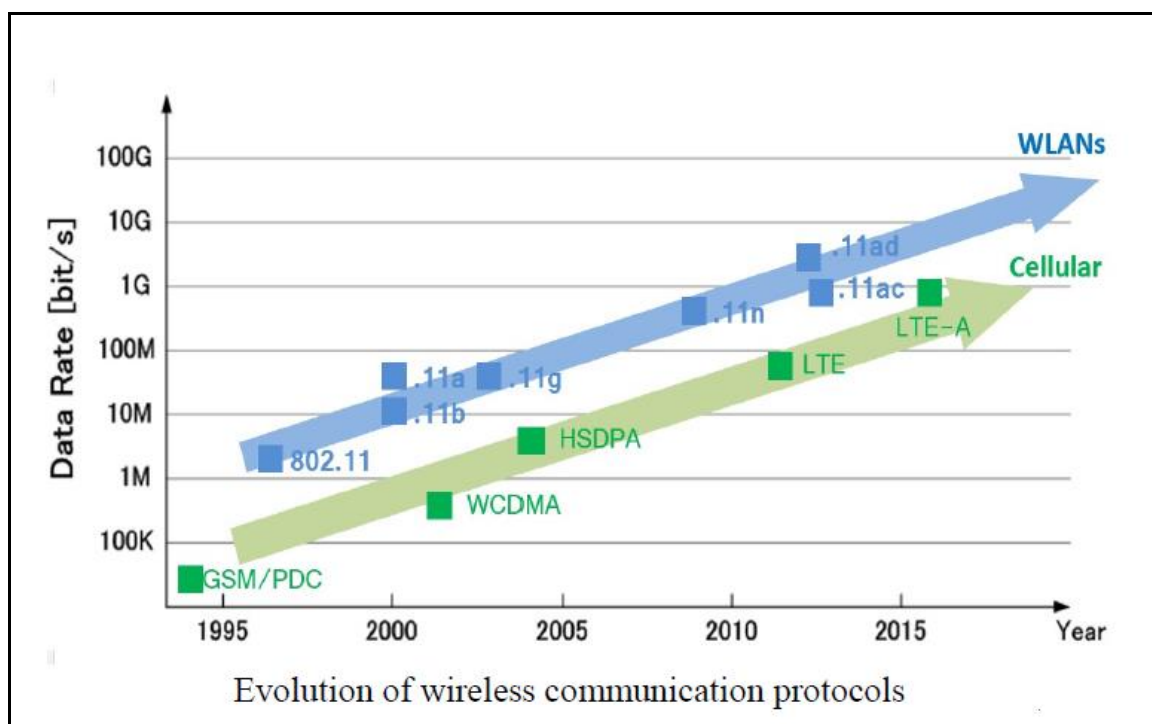

This technology places its starting point in 1997 with the IEEE 802.11 protocol. The first 802.11b Wi-Fi standard (1999) had a top link speed of 11 Mbps. A good first step, but significantly slower than a wired connection. A few years later the 802.11a/g revision (2003) increased the speed to 54 Mbps with the introduction

of Orthogonal Frequency Division Multiplexing (OFDM) technology. The next link speed improvement came with 802.11n (2009) presenting users with single stream links up to 150 Mbps. The 802.11ac revision of the standard (2013) brought with it the possibility of link speeds around 866 Mbps on a single spatial stream with wider channels (160MHz) and higher modulation orders (256-QAM). Using the specified maximum number of 8 spatial streams, this engineering marvel would, in theory, reach its top speed of 6.97 Gbps. However, speeds approaching 7 Gbps might only be achievable in the controlled race track environment of the RF lab. In reality, users commonly experience frustratingly slow data traffic when trying to check their email on a public Wi-Fi at a busy airport terminal. Table I summarizes the characteristics of each one amendment.

TABLE I. IEEE 802.11 amendments

802.11 Amendments	Responsibility
802.11a Approved in 1999	Specification enabling up to 54 Mb/s to be achieved in the 5 GHz unlicensed radio band by utilizing orthogonal frequency division multiplexing (OFDM).
802.11b Approved in 1999	Specification enabling up to 11 Mb/s to be achieved in the 2.4 GHz unlicensed radio band by utilizing high rate direct sequence spread spectrum (HR/DSSS).
802.11d Approved in 2001	Covers additional regulatory domains, which facilitates the development of WLAN devices that comply with the wireless communications regulations of their respective countries.
802.11c Approved in 2001	Provides required information to ensure proper bridge operations, which is required when developing access points.
802.11f Approved in 2003	Covers Inter Access Point Protocol (IAPP), ensuring the user can roam in the different access points.
802.11g Approved in 2003	Specification enabling high data rate up to 54 Mb/s to be achieved in the 2.4 GHz unlicensed radio band.
802.11h Approved in 2003	Covers dynamic frequency selection (DFS) and transmit power control (TPC). The protocol solves the interferential problem of satellites and radar that using the identical 5 GHz frequency band.
802.11i Approved in 2004	Enhance WLAN security to replace the previous security specification Wired Equivalent Privacy (WEP).
802.11j Approved in 2004	Specially designed for Japanese market. It allows Wireless LAN operation in the 4.9 to 5 GHz band.
802.11e Approved in 2005	Defining a set of Quality of Service (QoS) enhancements for wireless LAN applications through modifications to the MAC layer.
802.11r Approved in 2008	Provide the fast and secure handoffs from one base station to another managed in a seamless manner.
802.11n Approved in 2009	Supporting for MIMO technology and security improvements utilized in the 2.4 GHz or 5 GHz frequency bands and the transmission speed is greater than 100 Mb/s.
802.11p Approved in 2010	For wireless access technology applied on wireless access in vehicular environments (WAVE), defined the architecture of communications system and a series of standardized services.
802.11s Approved in 2011	Defining the wireless mesh network. The wireless devices can interconnect to create a wireless mesh network.

For the creation of new mechanisms and amendments to IEEE 802.11, a new research group was formed in 2014 with the name HEWG (High Efficiency Working Group), which aims to develop the new standard. A new revision of the IEEE 802.11 wireless LAN standard – 802.11ax – seeks to remedy exactly this precise situation. 802.11ax, also, has the challenging goal of improving the average throughput per user by a factor of at least 4X in dense user environments. Looking beyond the raw link speeds of 802.11ac, this new standard implements several mechanisms to serve more users consistent and reliable data throughput in crowded wireless environments. The 802.11ax standard holds great promise, especially for dense deployments in both indoor and outdoor environments and increase throughput while improving power efficiency for mobile devices.

To understand better 802.11ax, it's crucial first to take a step back and look at 802.11ac. The 802.11ac standard allows up to 4 spatial streams of data. The 802.11ax draft specification, builds on 802.11ac by doubling the number of spatial streams and significantly improving the efficiency of those streams. The 802.11ax, like 802.11ac, also operates in the 5-GHz band where there is more space for its 80-MHz and 160-MHz channels.^{1 2}

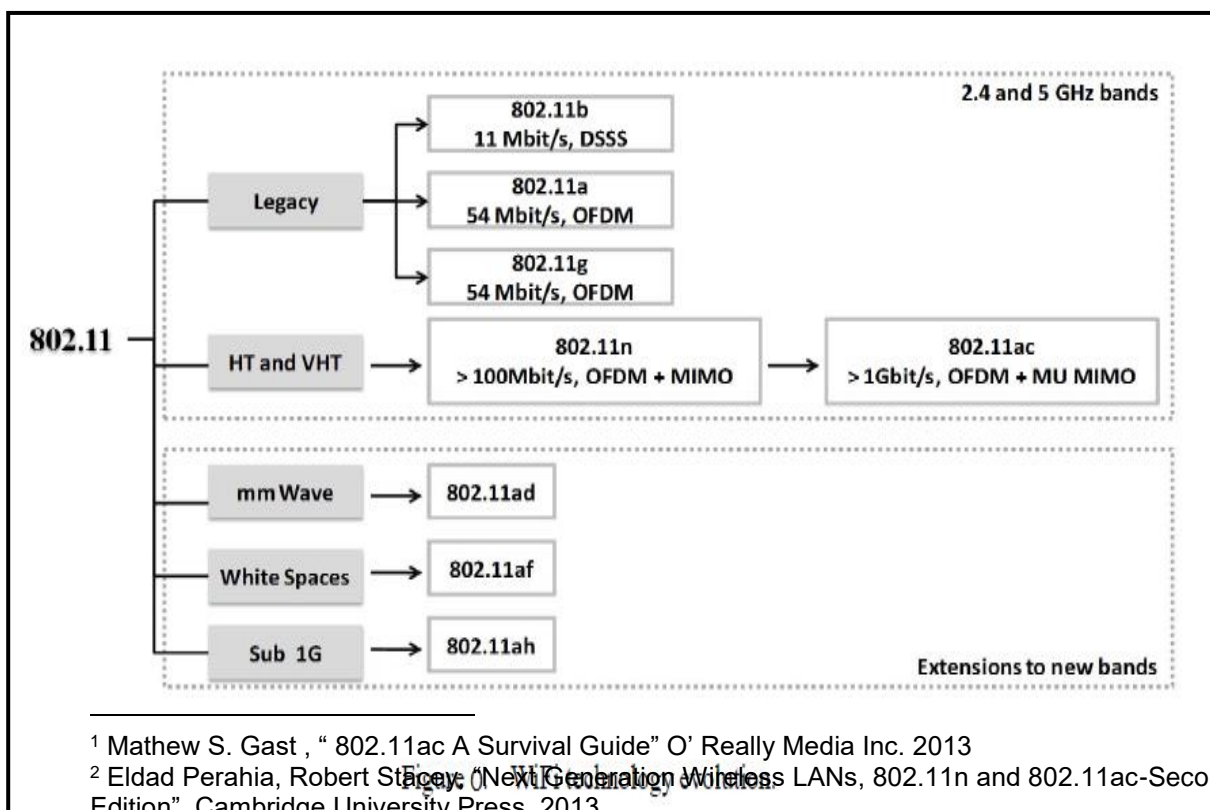

1. Developments in the IEEE 802.11n IEEE 802.11ac and ax

A key feature of the standard IEEE 802.11ac is to extend the range of the channel zone 80 and 160 MHz. Additionally, this model supports the use of non-contiguous (non-adjacent) channel for transmission. For example, two non-contiguous 80 MHz channels may be used to form a transmission 160 by summing the two channels 80 + 80 MHz. Consequently, the number of spatial data transmission flow increased to 8. Spatial streams meant one or more individual data streams transmitted from the antennas of the devices. The magnitude of the modulation is increased to 256 QAM achieving a 33% increase in data rates, when the quality of the coupling permits. In addition, the IEEE 802.11ac amendment extends the multiple input multiple output (MIMO) of the IEEE 802.11n to allow multiple users (multi-user) MIMO transmission. In this manner, it allows simultaneous transmission to multiple devices and improves network capacity.

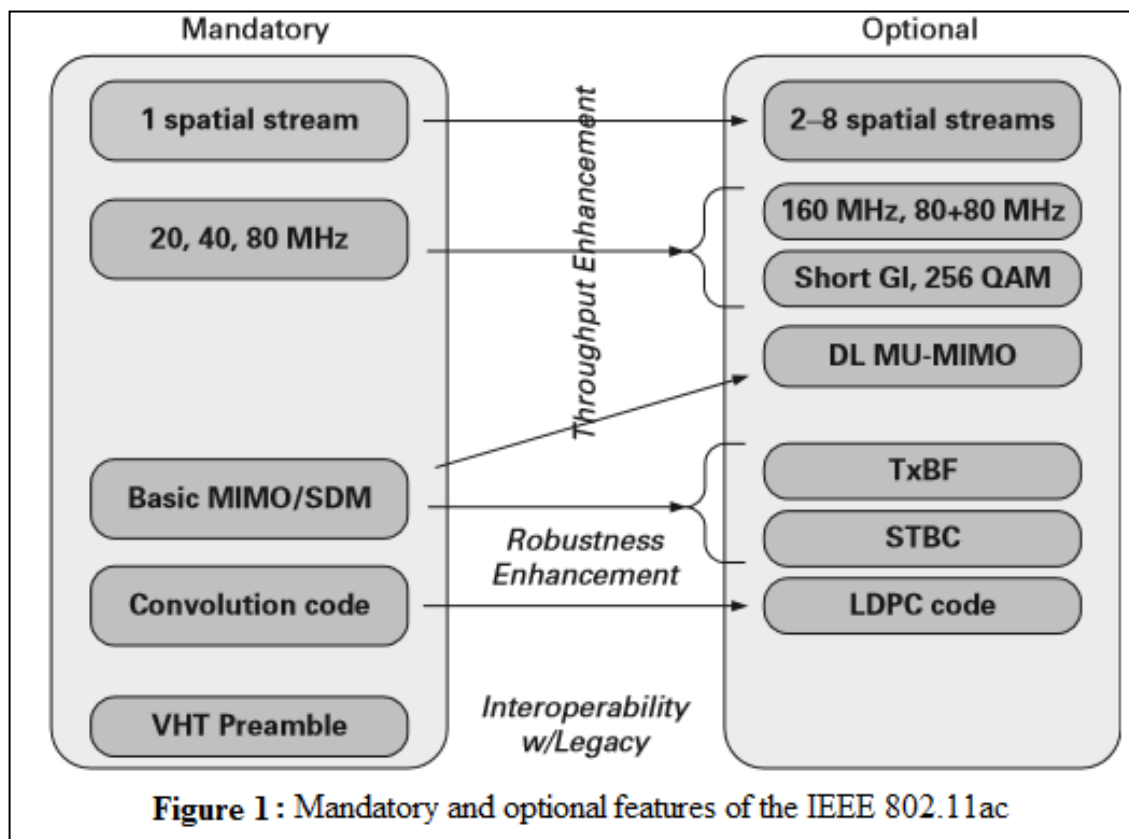
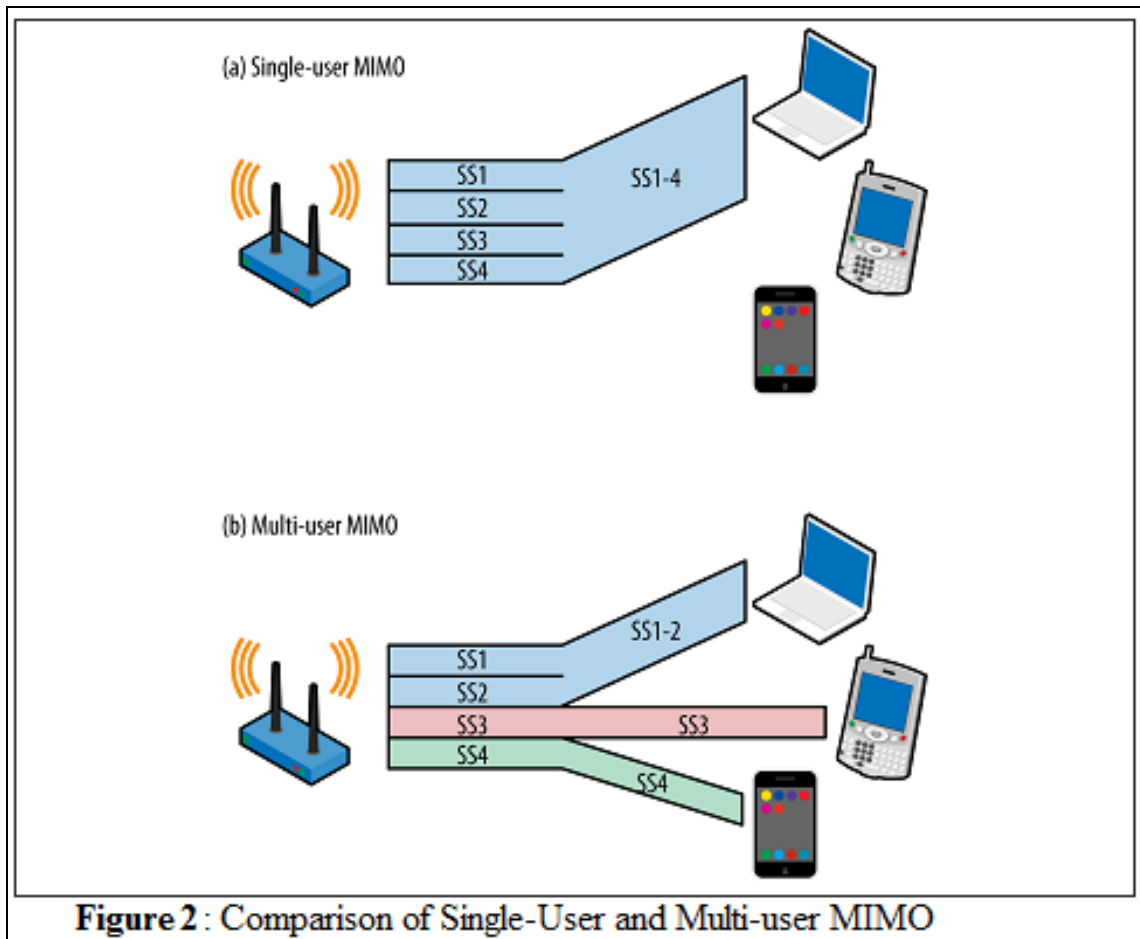
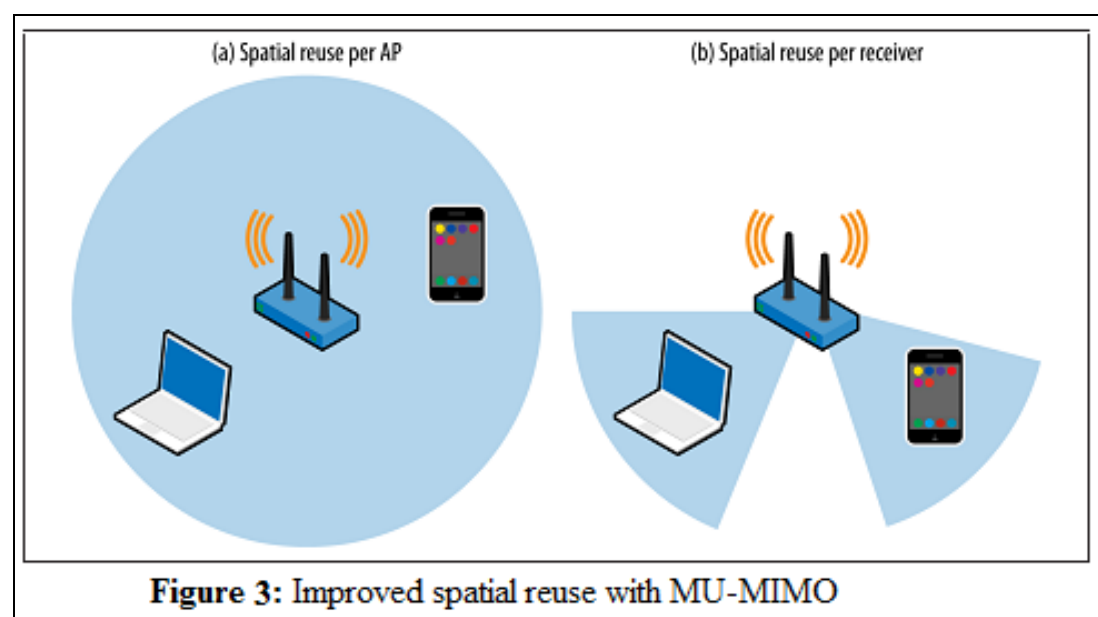

Figure 1 shows the required and optional features that must support and implement the IEEE 802.11ac. The main enhancement in data rate is 80 MHz. Also, beamforming in transmission will be included in the IEEE 802.11ac devices. Some of these devices will implement the feature STBC (Space time Block Coding). This feature enhances the robustness, and achieves fast link adaptation through rapid monitoring mechanism of the changes relating to the channel condition. The LDPC (Low-density parity-check code) is a bar code error correction by transmission of a message in a noisy channel.

Using the Beamforming and introduction of MU-MIMO in IEEE 802.11ac standard, better spatial reuse is achieved in dense LANs.





Figures 2 and 3 show, that through Beamforming, the energy of the signals 'weigh' best AP and each operator the information of the channel status, directing the signals to the receivers. Consequently, better exploitation of the channel is performed by improving the spatial reuse. Furthermore, in the IEEE 802.11ac transmission, Beamforming is simplified compared with the IEEE 802.11n standard which has many options making difficult interoperability between different manufacturers. In IEEE 802.11ac, the transmit Beamforming limited to direct feedback mechanism.

In addition, the IEEE 802.11n and IEEE 802.11ac have introduced mechanisms, cumulative packet or data or control (CTS / ACKs), for the purpose of less overload of the medium. The aggregation frame (Frame Aggregation) was initially introduced to amend IEEE 802.11n to improve network performance. The aggregation functions in such was as to reduce the relative amount of overload resulting from competition from stations to access the medium. However, the IEEE 802.11ac standard introduced an innovation with respect to aggregation. All transmitted frames use the Aggregated Mac Protocol Data Unit (A-MPDU). The A-MPDU transmissions should always be in a MAC layer to take over the entire responsibility of creating frames (Framing).

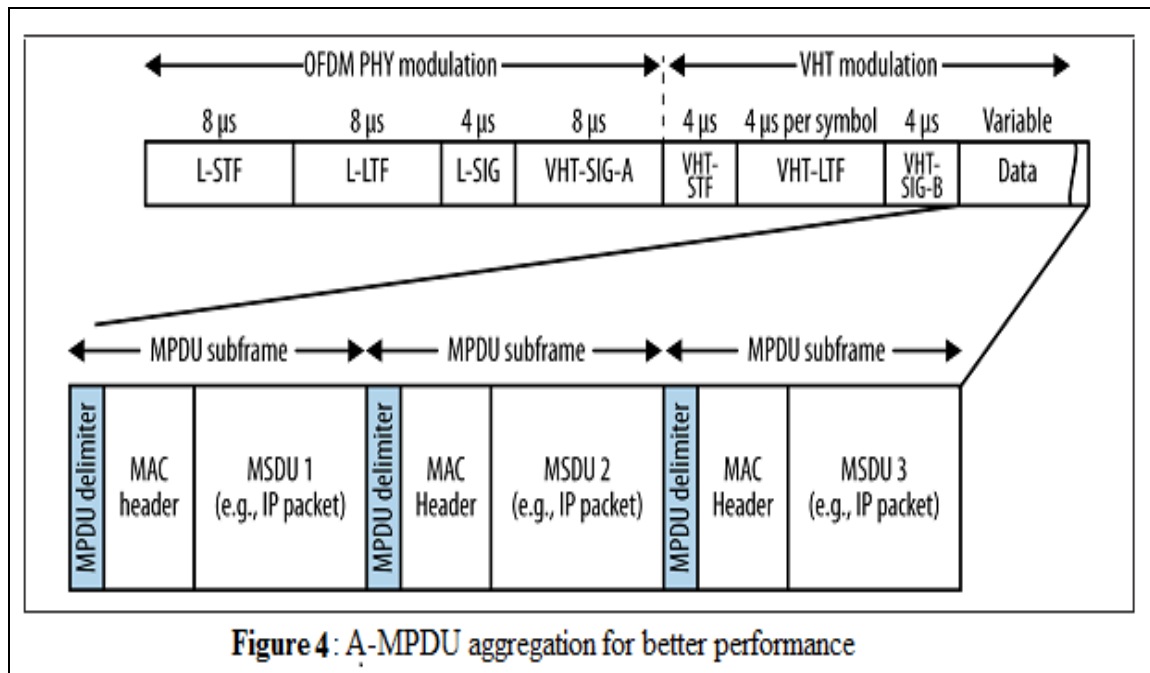

MSDUs pellets obtained from the LLC (Logical Control Link), intended for the same recipient, can be agglomerated and be encapsulated in a single MAC protocol data unit (A-MPDU) which is called MAC Protocol Data Unit.

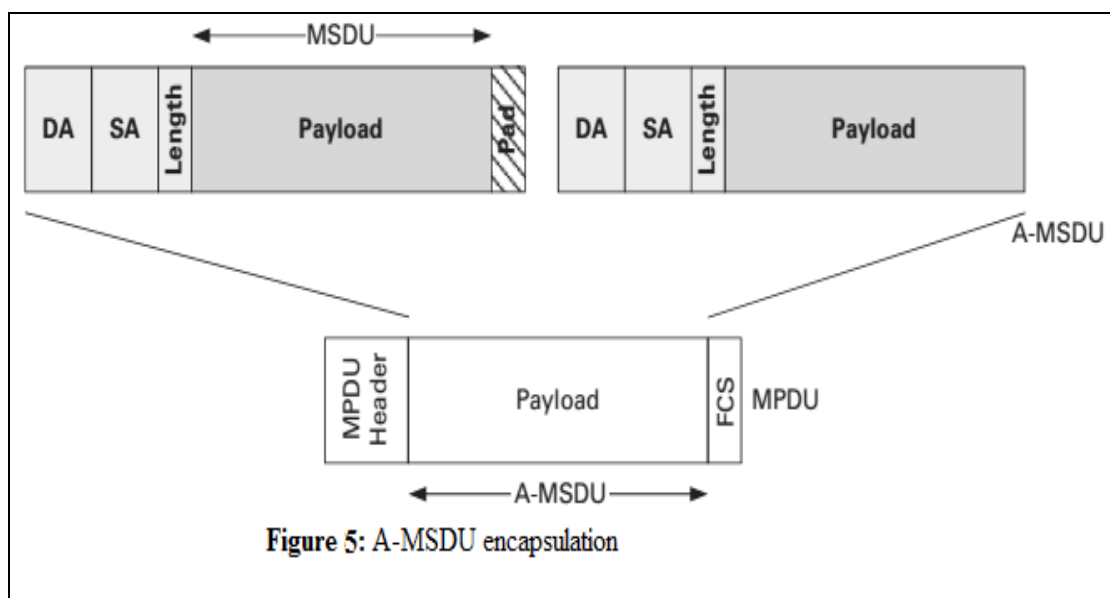

The MSDU as obtained from LLC, added one subframe header of 14 bytes, composed of:

- ✓ destination address (DA)
- ✓ source address (SA)

A length field gives the length of the SDU in bytes. The header with the SDU, supplemented with 0 to 3 bytes to form the sub-frame of 32 bytes. Many such subframes can be placed in consecutive order to form the load of the frame data QoS, provided that the total length does not exceed the maximum size of the MPDU.

Each station must support the transmission and receipt of aggregated frames. The maximum length A-MSDU which a station can receive is determined by the information element of the HT (High Throughput) capability. MAC PDUS agglomerate is fully formed with aggregation MPDU (A-MPDU), at the bottom of MAC level. A short delimiter is placed before each MPDU and aggregation occurs on the physical plane as PSDU (Physical Service Data Unit) for transmission in a single PPDU (Physical Protocol Data Unit).

Aggregation frame is supported in IEEE 802.11ac. In each box there is information indicating element, which refers to the property for Frame support very high throughput (VHT-Very-High Throughput). A VHT MPDU can have 3895 bytes in length, 7991 bytes and 11454 bytes. The first two values result from the length of the HT PPDU A-MSDU adding header MAC. The last value was chosen due to its maximum frame size, for which 32 bits FCS (Frame Check Sequence) detects three, two or one wrong bit.

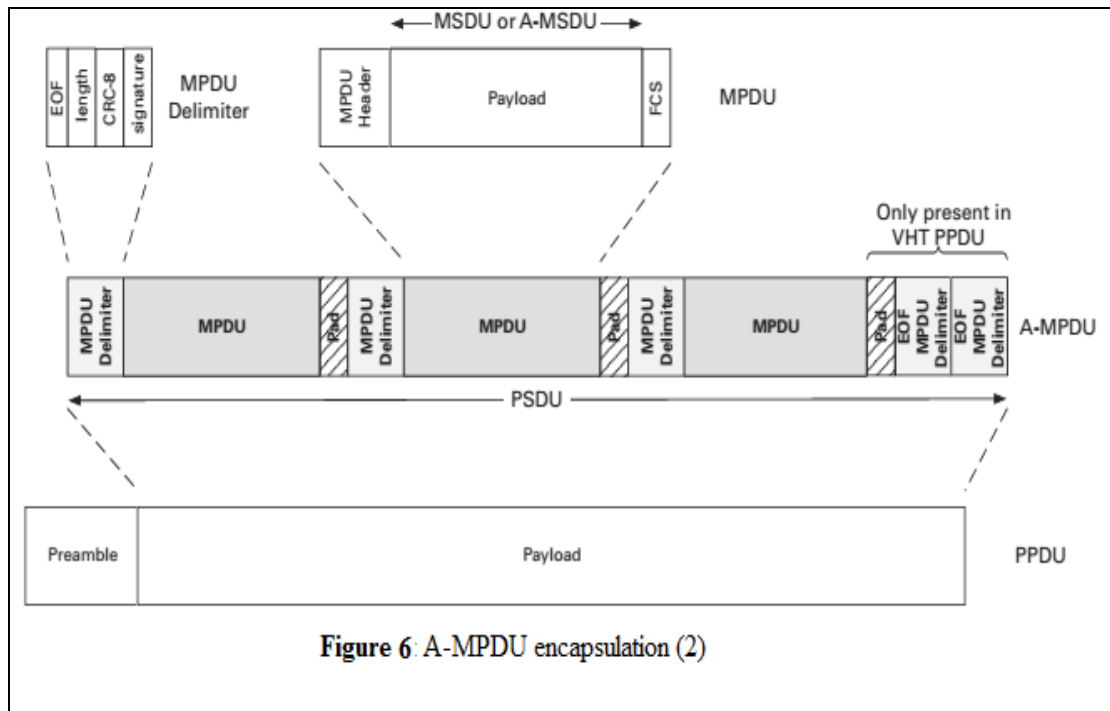

	802.11ac	802.11ax
Main Frequency Bands	5 GHz	2.4 GHz and 5 GHz
Channel Bandwidth (MHz)	20, 40, 80, 160, 80+80	Unlikely to change from 802.11ac
Number of spatial streams	1, 2, 3, 4, 5, 6, 7, 8	Unlikely to change from 802.11ac
Modulation	BPSK, QPSK, 16QAM, 64QAM, 256QAM	Unlikely to change from 802.11ac
Maximum PHY Data rate	6933 Mbps (SSS, 160MHz, 256QAM, short guard interval)	Unlikely to change from 802.11ac
Advanced technologies	Downlink MU MIMO, Dynamic/static channel bandwidth operation with RTS/CTS	STR, Downlink and Uplink OFDMA, Uplink MU MIMO, Dynamic CCA

Table 1: Basic technological parameters for IEEE 802.11ac and IEEE standards 802.11ax

Table 1 shows the basic technologies which will remain the same as well as both modifications and those which will be expanded in IEEE 802.11ax. The table shows, that the IEEE 802.11ax will work in the zone of 2.4 GHz. The advanced mechanisms, will support simultaneous transmit and receive (STR), using OFDMA the uplink (UL), down link (DL) and finally the dynamic adjustment CCA depending

on the channel conditions. The aim of the latter mechanism is to achieve greater spatial reuse and reduce interference in overlapping BSS environments.

2. Evolution 802.11ac, 802.11ax

What makes 802.11ax so appealing is its ability to dramatically increase throughput, while improving power efficiency for mobile devices. It is not just the theoretical system-level throughput that is improved, but actual real-world throughput achieved by individual users in high-density scenarios. The 802.11ax protocol promises consumers a dramatically better user experience, in all possible scenarios. Those are welcome news for emerging applications like interactive and high-definition video, which are often called on to work in challenging environments with a high density of Wi-Fi users (e.g., stadiums and public transportation).

To deliver on these objectives, 802.11ax must utilize a number of different technologies. While it is anticipated that the standard will be based around OFDM, some of the other technologies are currently under consideration including: OFDMA, MU-MIMO and higher order modulation. Orthogonal Frequency-Division Multiple Access, a backward-compatible enhancement to OFDM. In OFDM, the total channel bandwidth (20 MHz, 40 MHz, 80 MHz, etc.) contains multiple OFDM sub-carriers. Presently in OFDM, any frame transmission has to use all the sub-carriers in the bandwidth.

However, in OFDMA, different subsets of sub-carriers in the channel bandwidth can be used by different frame transmissions at the same time. (This is not to be confused with MU-MIMO of 802.11ac.) Sub-carriers can be allocated to transmission in blocks as small as 2 MHz.

The 802.11 protocol uses a carrier sense multiple access (CSMA) method in which the wireless stations (STA) first sense the channel and attempt to avoid collisions by transmitting only when they sense the channel is idle. That is, when they don't detect any 802.11 signals. When an STA hears another one, it waits for a random amount of time for that STA to stop transmitting before listening again for the channel to become free. When they are able to transmit, STAs transmit their whole packet data.

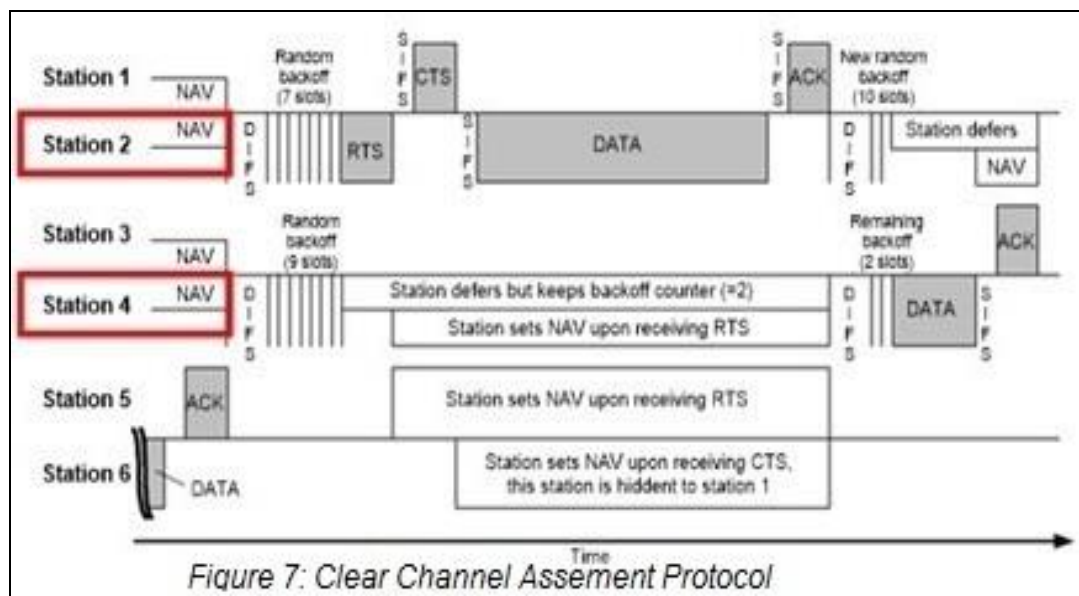

Wi-Fi STAs may use Request to Send/Clear to Send (RTS/CTS) to mediate access to the shared medium. The Access Point (AP) only issues a CTS packet to one STA at a time, which in turn sends its entire frame to the AP. The STA then waits for an acknowledgement packet (ACK) from the AP indicating that it received the packet correctly. If the STA does not get the ACK in time, it assumes the packet is collided with some other transmission, moving the STA into a period of binary exponential backoff. It will try to access the medium and re-transmit its packet after the backoff counter expires.

Although this Clear Channel Assessment and Collision Avoidance protocol serves well to divide the channel somewhat equally among all participants within the collision domain, its efficiency decreases when the number of participants grows very large. Another factor that contributes to network inefficiency is having many APs with overlapping areas of service. The figure 8 depicts a user (User 1) that belongs to the Basic Service Set (BSS, a set of wireless clients associated to an AP) on the left. User 1 would contend for access to the medium with other users in its own BSS and then exchange data with its AP. However, this user would still be able to hear traffic from the overlapping BSS on the right.

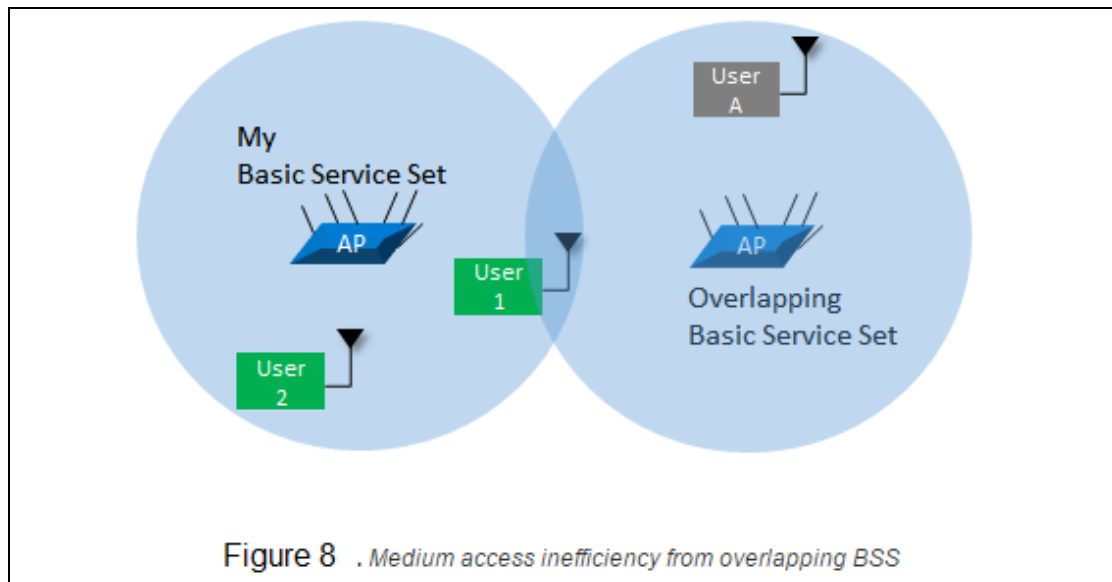

In this case, traffic from the OBSS would trigger User 1’s backoff procedure. This kind of situation results in users having to wait longer for their turn to transmit, effectively lowering their average data throughput. A third factor to consider is the shared use of wider channels.

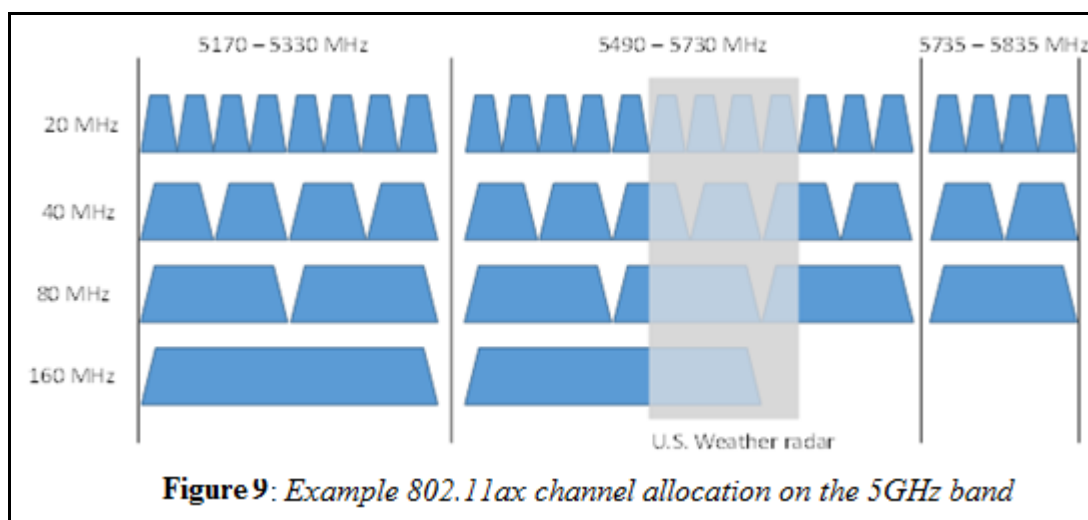

Planning dense coverage with a reduced number of channels becomes very difficult, forcing network managers to reuse channels in nearby cells. Without careful and deliberate power management, users will experience co-channel interference, which degrades performance and negates much of the expected gain from the wider channels. This is especially true for the top data rates of MCS 8, 9,

10, and 11, which are much more susceptible to low signal to noise ratio. Also, on the current implementation of 802.11 networks, a 20 MHz channel overlapping an 80 MHz channel will basically render the 80 MHz channel useless, while a user transmits on the narrower channel. Implementing 802.11ac's Channel Sharing in a high density network compromises the gains of the 80 MHz channel for transmissions on a 20 MHz channel.

The 802.11ax specification introduces significant changes to the physical layer of the standard. However, it maintains backward compatibility with 802.11a/b/g/n and /ac devices, such that an 802.11ax STA can send and receive data to legacy STAs. These legacy clients will also be able to demodulate and decode 802.11ax packet headers – though not whole 802.11ax packets – and backoff when an 802.11ax STA is transmitting.

Notice that the 802.11ax standard will operate in both the 2.4 GHz and 5 GHz bands. The specification defines a four times larger FFT, multiplying the number of subcarriers. However, one critical change with 802.11ax is that the subcarrier spacing has been reduced to the one-fourth of the subcarriers spacing of previous 802.11 revisions, preserving the existing channel bandwidths.

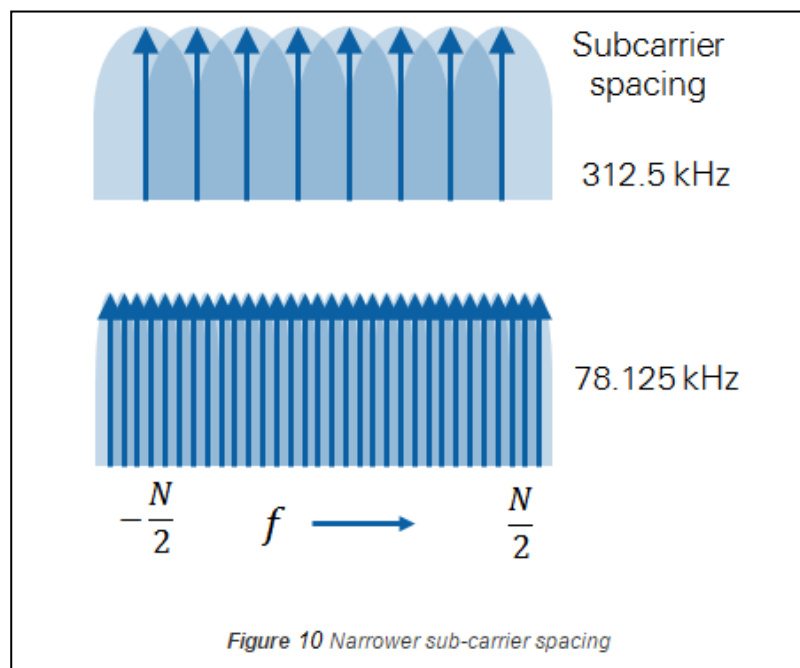

3. MAC Mechanisms for High Efficiency

3.1 Spatial Reuse

To improve the system level performance and the efficient use of spectrum resources in dense deployment scenarios, the 802.11ax standard implements a spatial reuse technique. STAs can identify signals from overlapping Basic Service Sets (BSS) and make decisions on medium contention and interference management based on this information.

When an STA that is actively listening to the medium, detects an 802.11ax frame, it checks the BSS color bit or MAC address in the MAC header. If the BSS color in the detected PPDU is the same color as the one that the associated AP has already announced, then the STA considers that frame as an intra-BSS frame.

However, if the detected frame has a different BSS color than its own, then the STA considers that frame as an inter-BSS frame from an overlapping BSS. The STA then treats the medium as BUSY only during the time it takes the STA to validate that the frame is from an inter-BSS, but not longer than the time indicated as the length of the frame's payload.

The standard still has to define some of the mechanisms for ignoring traffic from overlapping BSSs, but the implementation could include raising the clear channel assessment signal detection (SD) threshold for inter-BSS frames, while maintaining a lower threshold for intra-BSS traffic. That way, traffic from neighboring BSS would not create unnecessary channel access contention.

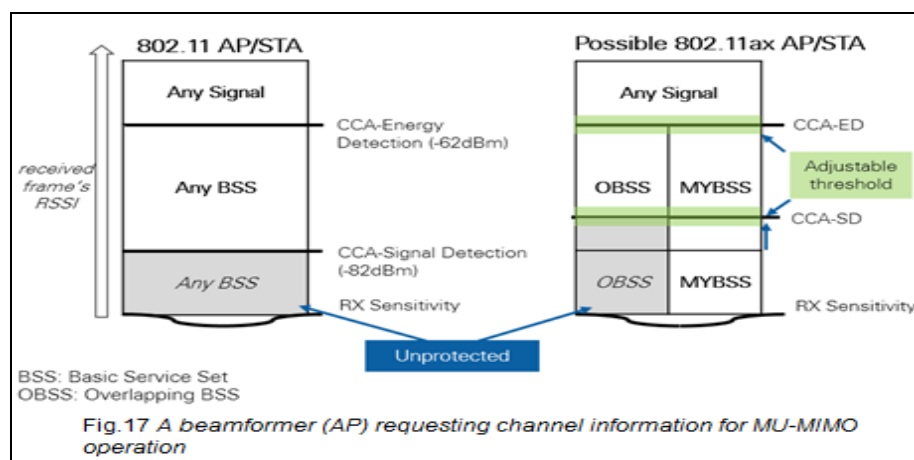

When 802.11ax STAs use the color code based CCA rule, they are also allowed to adjust the OBSS signal detection threshold together with transmit power control. This adjustment improves system level performance and the use of spectrum resources. Furthermore, 802.11ax STAs can adjust CCA parameters, such as the energy detection level and the signal detection level.

In addition to using CCA to determine if the medium is idle or busy for the current frame, the 802.11 standard employs a Network Allocation Vector (NAV) – a timer mechanism that maintains a prediction of future traffic – for STAs to indicate the time required for the frames immediately following the current frame. The NAV acts as a virtual carrier sense that ensures medium reservation for frames critical to operation of the 802.11 protocol, such as control frames, and data and ACKs following an RTS/CTS exchange.

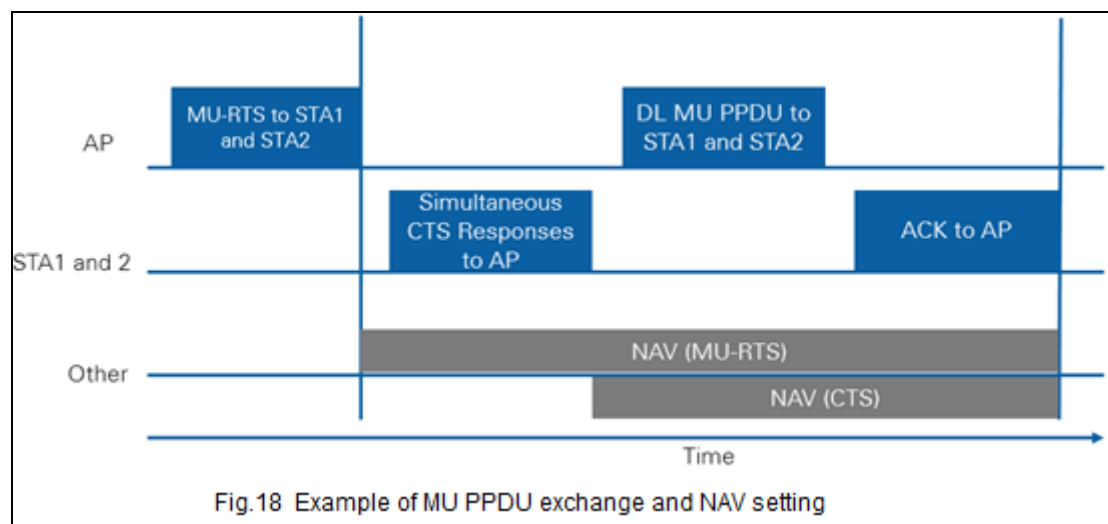

The 802.11 Task Group working on High-Efficiency Wireless will possibly include not just one NAV field, but two different NAVs to the 802.11ax standard. Having an intra-BSS NAV and an inter-BSS NAV could help STAs to predict traffic within their own BSS and feel free to transmit when they know the state of overlapping traffic.

3.2. Power-saving with Target Wake Time

An 802.11ax AP can negotiate with the participating STAs, the use of the Target Wake Time (TWT) function to define a specific time or set of times for individual stations to access the medium. The STAs and the AP can exchange information that includes expected activity duration. In this way the AP controls the level of contention and overlap among STAs needing access to the medium. 802.11ax STAs may use TWT to reduce energy consumption, entering a sleep state until their TWT arrives. Furthermore, an AP can additionally devise schedules and deliver TWT values to STAs without individual TWT agreements between them. The standard calls this procedure Broadcast TWT operation, as Figure 19 shows.

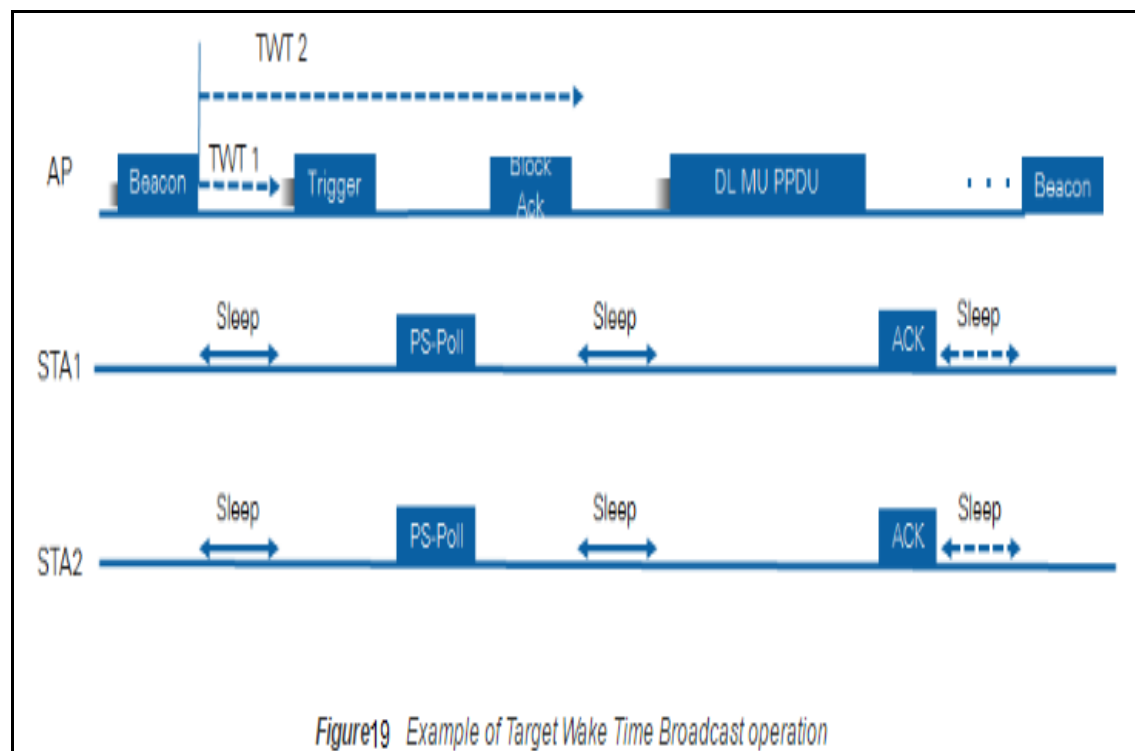

3.3. Clear Channel Assessment (CCA)

IEEE 802.11ax is a set of media access control (MAC) and physical layer (PHY) specification for implementing wireless local area network (WLAN) computer communication in the Wi-Fi frequency bands. The standards and amendments provide the basis for wireless network products using the Wi-Fi frequency bands.

The efficient reuse of the available frequency band by geographically separated BSSs is particularly important for HEWs to manage interference among OBSSs, especially in dense HEW deployment scenarios. The improving spatial frequency reuse in HEWs, based on enhanced CCA and FFR as we see in Table 2.

TABLE 2 : Classification of potential HEW spatial frequency reuse schemes

HEW Spatial Frequency Reuse Schemes	Enhanced CCA	Fixed CCA enhancements
		Dynamic CCA enhancements
		Enhanced CCA with transmit power control
		Enhanced CCA with BSS coloring
	FFR	Static FFR schemes
		Dynamic FFR schemes

The CCA is a function defined in the IEEE 802.11 standard to determine the current state of the wireless channel, i.e., busy or idle, either by Wi-Fi or by non-Wi-Fi signals³. If a Wi-Fi signal is detected above a pre-defined threshold, referred to as the CCA carrier sensing (CCA-CS) level or a non-Wi-Fi, signal is detected above another pre-defined threshold, referred to as the CCA energy detection (CCA-ED)

³“IEEE standard for information technology–telecommunications and information exchange between systems local and metropolitan area networks–specific requirements part 11: Wireless LAN medium access control (MAC) and physical layer (PHY) specifications,” pp. 1–2793, Mar. 2012.

level, the CCA function indicates that the wireless channel is currently captured by another STA or non Wi-Fi devices. Thus, the STA which detects the wireless channel as busy, defers its channel access, in order to avoid interference. In the IEEE 802.11 standard, the CCA-CS and CCA-ED levels have constant values, which are listed in Table 3.

TABLE 3 : CCA levels defined in [12]

Bandwidth	CCA-CS level	CCA-ED level
5 MHz	-88 dBm	-78 dBm
10 MHz	-85 dBm	-75 dBm
20 MHz	-82 dBm	-72 dBm

The CCA levels are set to the very low values in order to:

- a) Increase the communication range among STAs,
- b) Decrease the interference power level that is allowed at a receiver STA, and
- c) Reduce the impact of the hidden terminal problem, since a hidden STA defers its channel access only if it receives a signal (e.g., an RTS or CTS frame) with power above the CCA level. These low CCA levels can work well in WLANs with low AP densities and with a proper AP channel selection algorithm.

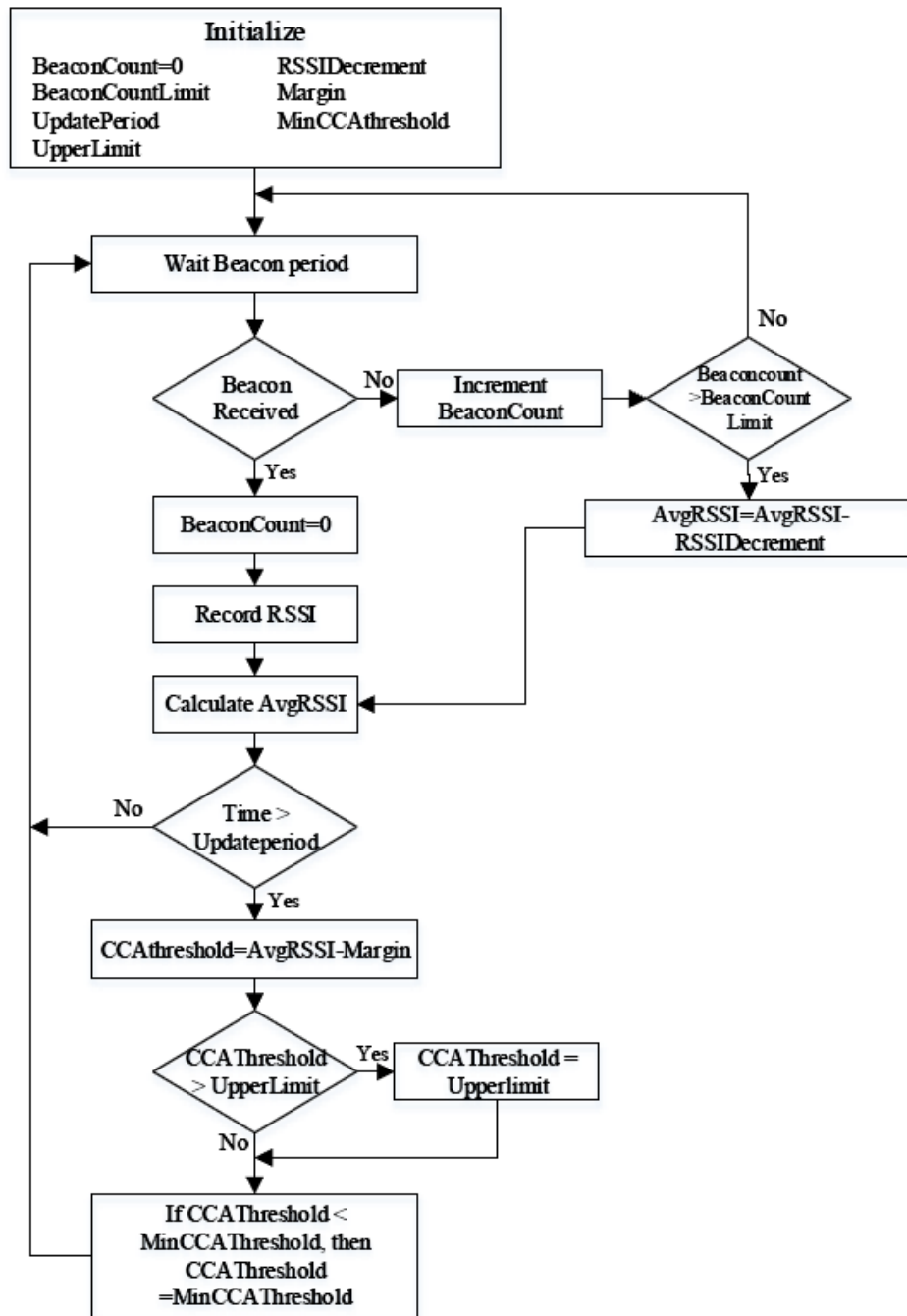

In a dense HEW deployment scenario, a low CCA level may cause an ongoing transmission in a BSS to prevent many STAs in the OBSSs from accessing the channel, which degrades the overall performance of HEWs.

Hence, in order to allow for concurrent transmissions with high transmission rates in adjacent BSSs, enhanced CCA mechanisms are required to improve the

spatial frequency reuse for HEWs. To further clarify the basic concept of enhanced CCA mechanisms, consider the scenario in Fig. 20.⁴

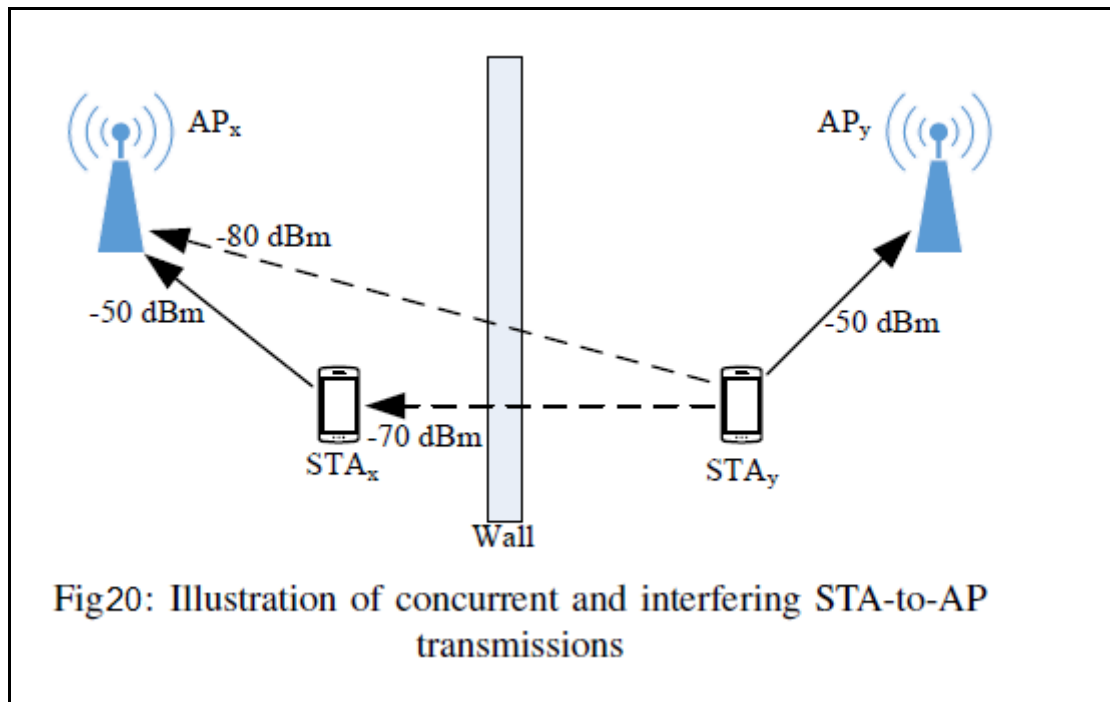

STA_x transmits to AP_x and STA_y transmits to AP_y, the received signal power at AP_x (from STA_x) and that at AP_y (from STA_y) are both -50 dBm. Due to signal path loss and wall penetration, AP_x and STA_x receive signals with powers of -80 dBm and -70 dBm, respectively, from STA_y. Comparing the received signal power (STA_x to AP_x) with the interference signal power (STA_y to AP_x), STA_x and STA_y can both transmit successfully due to a large received signal-to-interference-plus-noise ratio (SINR). If the original CCA mechanism I, employed only one STA can transmit while the other one is suppressed from transmitting due to detecting a signal above the CCA level (STA_y to STA_x). In TABLE 3 we see the CCA levels.

This exposed terminal problem is particularly important to consider in an HEW with a high STA density, since a single transmission may suppress simultaneous transmissions from many other surrounding STAs, which can greatly degrade the network performance.

⁴ IEEE, "E specification 802.11-2007," 2007.

Fixed CCA Enhancements:

A straightforward solution to enhance the CCA function is to increase the CCA threshold (CCAT), to a certain value such that HEW STAs which can transmit despite the presence of signals from OBSS STAs.

The advantages of this CCA enhancement are:

- ✓ implementation simplicity
- ✓ possible high throughput

Increasing CCAT can potentially increase the average per-STA throughput, due to allowing more concurrent transmissions in the same area. Increasing CCAT can reduce the minimum per-STA throughput at the edge of the BSA. The reason is that STAs located at the edge of a BSA experience lower SINR, due to:

- ✓ a lower signal power received from the AP
- ✓ a higher interference resulting from the OBSS STA transmissions, which are more likely as a result of increasing the CCAT.

At a higher CCAT, the allowed interference power at a receiver STA increases the probability of a transmission collision also increases, since more concurrent transmissions are permitted⁵. Choosing the CCAT value creates a tradeoff between the amount of spatial reuse and the amount of interference. As a result, the impact of concurrent transmissions, interference, and transmission collisions on the HEW performance needs to be jointly considered when determining the value of CCAT.

Dynamic CCA Enhancements:

Fixed CCA enhancement methods can be efficient in scenarios where BSSs are deployed in a planned way and the STAs have low mobility. In a more complex scenario, where a large number of BSSs are densely deployed in an unmanaged

⁵ IEEE 802.11-13/1012, "Dynamic sensitivity control," 2014.

way and the STAs are frequently moving with high speeds, fixed CCA enhancement methods may not be able to maximize HEW performance.

Therefore, dynamic CCA schemes are required to be adaptive to complex HEW deployment scenarios and STA mobility. Since dynamic CCA methods are used to dynamically adjust the receiver sensitivity, they are usually referred to as dynamic sensitivity control (DSC) methods.

DSC methods can be either centralized or distributed. A centralized DSC method is executed by a central controller that dynamically adjusts CCAT values for APs/STAs according to their current status. The status of APs/STAs can be determined either by APs-to-STAs interference calculations or from APs/STAs topology information. A centralized method can improve spatial frequency reuse at the expense of the control overhead required to collect global network information. On the other hand, a distributed DSC method enables a STA to adjust its own CCAT value independently, using only local information. Local STA information can be based on packet loss rate, channel idle-busy ratio or on received signal strength from the AP. Although distributed DSC methods enhance robustness to HEWs topological changes, they can evoke fairness and hidden terminal problems, as CCAT values can be set too high.

One way to address this problem is by setting an upper bound on the CCAT value that is large enough to guarantee acceptable SINR and deal with sudden changes in the received signal strength of the AP beacons. A dynamic DSC method can adopt CCAT value adjustment for each PHY layer convergence procedure (PLCP) protocol data unit (PPDU)⁶. That is, a transmitting STA dynamically adjusts and announces the CCAT value for surrounding STAs. The aim of the dynamic adjustment is that, if a STA successfully transmits PPDU's successively, the surrounding STAs can use a higher CCAT value to improve the spatial frequency reuse. However, if a transmission fails, the STA resets the CCAT value for the surrounding STAs to a lower level.

The High Efficiency WLAN study group, is study group within IEEE 802.11 working group that will consider the improvement of spectrum efficiency to enhance the system throughput in high density scenarios of wireless devices. The HEW SG,

⁶ IEEE 802.11-14/1207, "OBSS reuse mechanism which preserves fairness," 2014

TGax was formed and tasked to work to IEEE 802.11ax standard that will become successor to IEEE 802.11ac.

The IEEE802.11ax PHY layer will be an evolution of the IEEE 802.11Ac. 802.11 and has always been a “listen-before-talk” protocol in which gaps in the transmission medium usage are an important component of the coordination process that divides up access to the medium among many stations. An important component of the 802.11ac standard is the way that a BSSID can switch channel bandwidth dynamically on a frame-by-frame basis. In any given collection of devices, it is easy to see how some might be line-powered devices without power-saving requirements and demanding the highest possible throughput, while others are battery-operated devices where battery life is at a premium. Rather than enforcing a one-bandwidth-fits-all approach, 802.11ac allows channel bandwidth to be determined on a frame-by-frame basis.

To help with dividing up airtime between channels, 802.11ac introduces the terminology of *primary* and *secondary* (or, more formally, *non-primary*) channels. The primary channel is the channel used to transmit something at its native bandwidth. Figure 21 is an illustration of the concept in the lowest eight available channels. For each channel bandwidth, there is one primary channel, meaning that it is the channel used to transmit frames at that channel width. This network will transmit 20 MHz frames on channel 60. To transmit a 40 MHz frame on its 40 MHz primary channel, both channels 60 and 64 must be free. To transmit an 80 MHz frame, the four channels 52 through 64 must all be free. Finally, to transmit a 160 MHz frame, all eight channels from 36 through 64 must be free. Table 4 shows the primary and secondary channels for each bandwidth. In practice, 802.11ac can share spectrum much more efficiently than 802.11n because detection of networks on non-primary channels is significantly better with 802.11ac hardware.

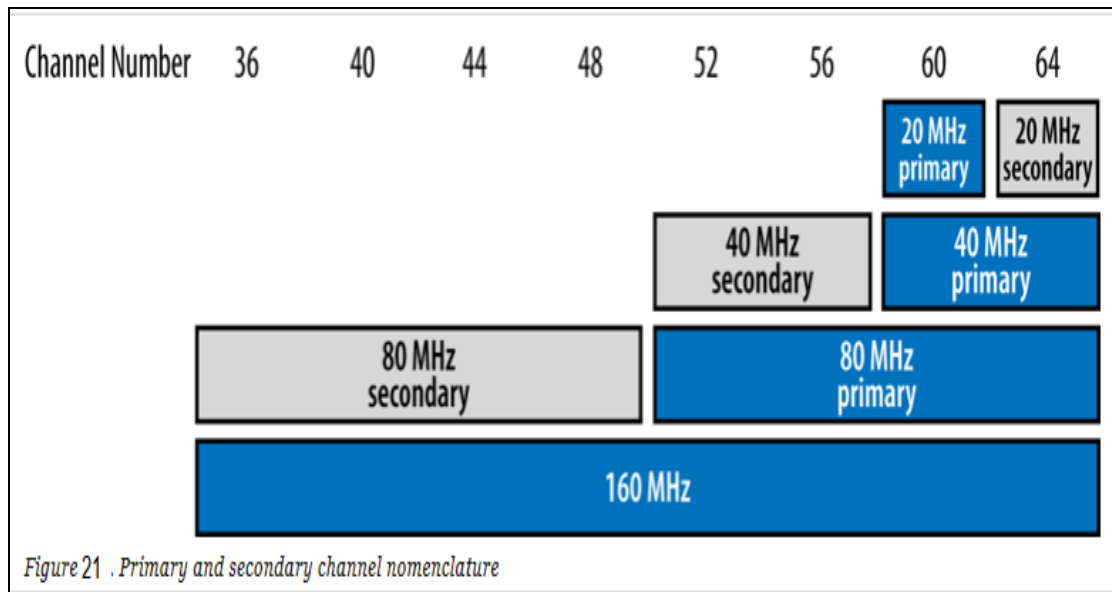
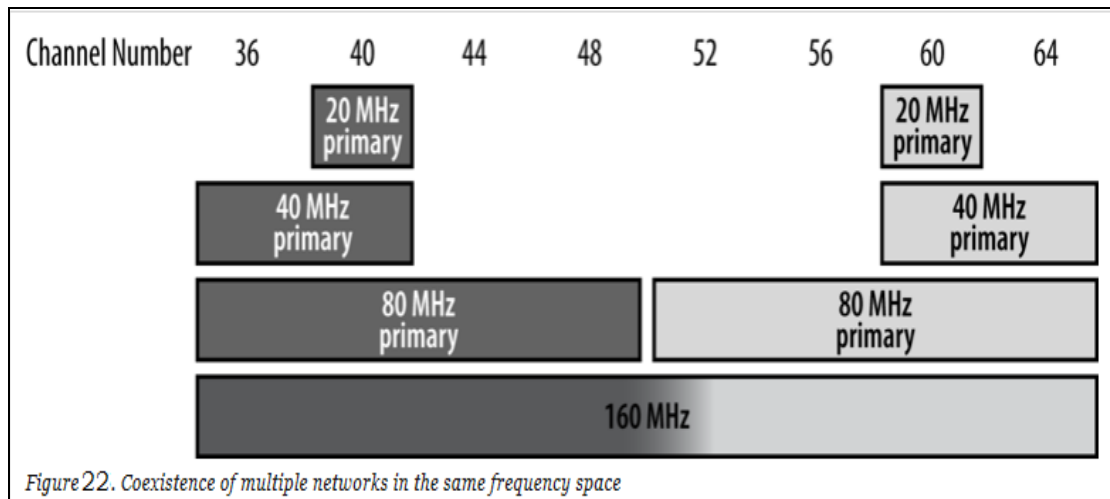

Table 4 . Primary and secondary channel relationships in Figure 21

Channel bandwidth	Primary channel	Secondary channel	Total number of 20 MHz channels
20 MHz	60	64	One (60)
40 MHz	60	52	Two (60, 64)
80 MHz	52	36	Four (52, 56, 60, and 64)
160 MHz	36	n/a	Eight (36, 40, 44, 48, 52, 56, 60, and 64)

One of the reasons for the notion of primary and secondary channels is that it helps multiple networks to share the same frequency space. Due to the wide variety of devices and data rates in use, a network that is designed for peak speed using 160 MHz channels will not always need the full capacity of the channel. Two networks, such as those shown in Figure 22, may share the same 160 MHz channel. They may both transmit 80 MHz frames at the same time because their primary 80 MHz channels are different.



The ability to share wider channels as shown in Figure 22 depends on the ability of an 802.11ac device to detect transmissions not only on its primary channel but also on any secondary channels in use. 802.11n's clear-channel assessment (CCA) capabilities on secondary channels were limited, and thus deploying two 802.11n networks that overlapped required in practice that the primary channels be identical.

802.11ac has sufficiently good secondary-channel CCA capabilities that two networks can readily be deployed without overlap, leading to gains for the whole network because a much larger fraction of transmissions can be done in parallel. This single subtlety in the specification allows for a wide range of deployment options for 802.11ac networks.

Basic channel access rules

The most basic channel access rule is that a frame can be transmitted if the medium is idle. Whether the medium is idle depends on how wide a channel the transmission is using. Once the relevant channel has been determined to be idle, a VHT device may:

- ✓ Transmit a 20 MHz frame on its primary 20 MHz channel. Clear-channel assessment looks only at the primary 20 MHz channel.

- ✓ Transmit a 40 MHz frame on its primary 40 MHz channel. Naturally, this requires that the secondary 20 MHz channel is also idle and has passed the CCA check.

- ✓ Transmit an 80 MHz frame on its primary 80 MHz channel. As you might expect at this point, this requires that both the primary 40 MHz channel and the secondary 40 MHz channel are idle.

- ✓ Transmit a 160 MHz frame on the 160 MHz channel, but only if both the primary and secondary 80 MHz channels are idle.

If any of the necessary channels are not idle, the device must report that the channel is busy and use the backoff procedure to reacquire the channel. With the backoff procedure, the transmitter will wait until the medium is idle, allow the distributed interframe space (DIFS) to elapse, and then attempt retransmission. As part of the retransmission, the device will select a random number to use as the slot number within the contention window. In most cases, the “winner” of a retransmission attempt during contention will be the station that selects the lowest backoff number.⁷

Sensitivity requirements

To report that the channel is busy, 802.11 has two methods:

- ✓ *signal detection*
- ✓ *energy detection*

Signal detection requires that a receiver find, lock onto, and begin decoding an 802.11-compatible signal. The second method, energy detection, looks only at the raw energy received in the band: if it is sufficiently high, the channel is reported as busy.

⁷ J. Zhu, X. Guo, L. Lily Yang, W. Steven Conner, S. Roy, and M. M. Hazra, “Adapting Physical Carrier Sensing to Maximize Spatial Reuse in 802.11 Mesh Networks: Research Articles,” *wireless communications and mobile computing*, vol. 4, no. 8, pp.33–946, Dec. 2004. doi: 10.1002/wcm.v4:8

802.11ac keeps the same rules for CCA sensitivity for 20 MHz and 40 MHz channels that were first adopted in 802.11n, and adds rules for the new wider channels.

Table 5 summarizes both the signal thresholds and the energy thresholds for primary and secondary channels. Two rules guide the development of these thresholds. First, every time the channel bandwidth doubles, the required signal threshold also doubles (+3 dB is a doubling of power). Second, the rule for energy detection is that on a non-primary channel, energy of 20 dB over the minimum sensitivity indicates that a channel will be busy because that is likely to be sufficient power to have an intelligible signal over the background noise.

Table 5 : CCA sensitivity thresholds

Channel width	Signal threshold (primary)	Signal threshold (non-primary)	Energy threshold (non-primary)
20 MHz	-82 dBm	-72 dBm	-62 dBm
40 MHz	-79	-72	-59
80 MHz	-76	-69	-56
160 MHz	-73	n/a ^[a]	n/a ^[a]

^[a] With 160 MHz channels, there are no secondary channels, so these thresholds are not defined.

Overlapping Basic Service Set

In computer networking, a service set (SS) is a set consisting of all the devices associated with a consumer or enterprise IEEE 802.11 wireless local area network (WLAN). The service set can be local, independent, extended or mesh. Service sets have an associated identifier, the service set identifier (SSID), which consists of 32 octets that frequently contains a human readable identifier of the network. The basic service set (BSS) provides the basic building-block of an 802.11 wireless LAN. In infrastructure mode, a single access point (AP) together with all associated stations (STAs) is called a BSS, not to be confused with the coverage of an access point, known as the basic service area (BSA). The access point acts

as a master to control the stations within that BSS; the simplest BSS consists of one access point and one station.

The working group TGax investigates ways of tackling the problem of overlapping basic service sets (OBSSs), through the efficient use of spatial resources and the available frequencies. The rise of simultaneous transmissions is a necessary feature to improve the rate of use of the spectrum in dense wireless environments LANs. The principal limiting factor for increasing the density of deployed APs is interference. When the distance between neighboring co-channel BSSs fall behind a minimum value, these BSSs overlap (transmissions occurring in one BSS are sensed in the neighboring overlapping BSSs). As a consequence, the transmissions of some STAs in one BSS affect some STAs in another BSS. This is commonly referred to as the Overlapping BSS (OBSS) problem. The number of available frequency channels is limited and the fact that the access to these channels is not licensed attracted many other technologies that are sharing today the spectrum with WLANs. Since the demand on capacity is escalating continuously, deploying more APs is necessary since the capacity of one AP is limited. In these circumstances, the OBSS problem is likely to be more produced.

All the issues described in a single BSS with high density of STAs can be extended to cover STAs belonging to different OBSSs. For instance, a legacy STA belonging to an OBSS affects the airtime fairness in the neighboring OBSS. Furthermore, when talking about OBSS problems, a STA in one BSS may be hidden to the STAs belonging of an overlapping BSS. Obviously, the reason is that two or more OBSSs share the same channel and hence their devices contend to gain access as if they are belonging to a single BSS.

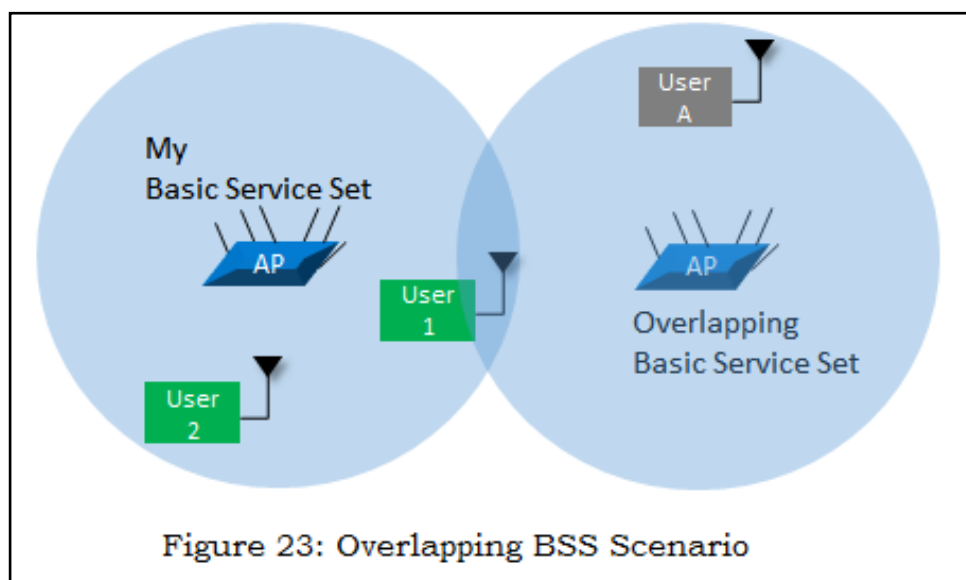
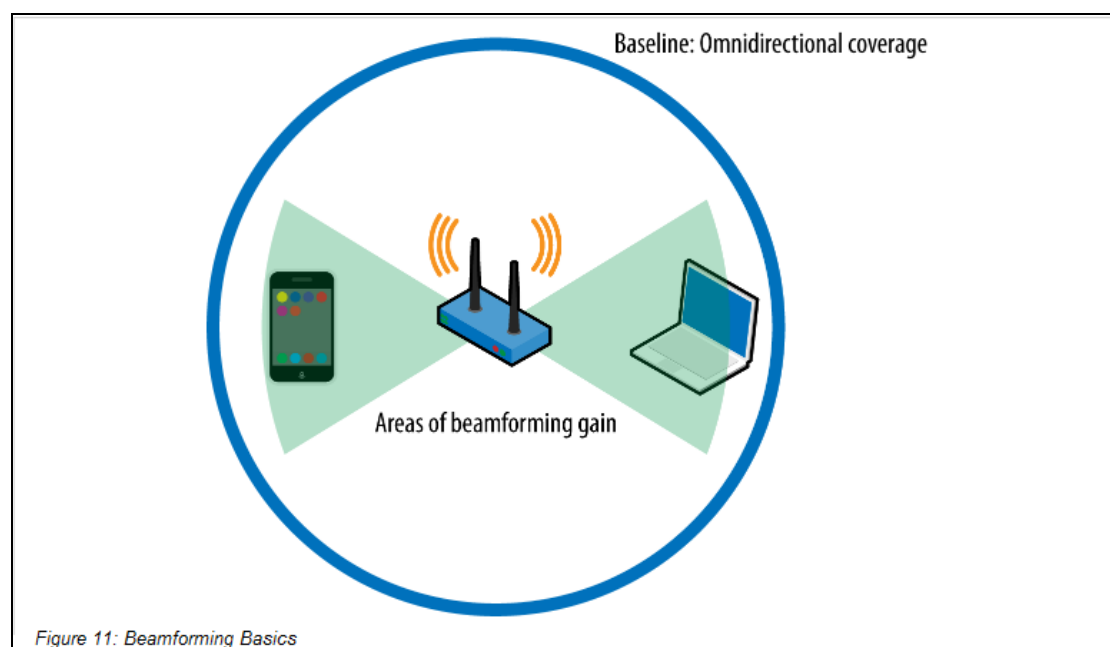

Figure 23: Overlapping BSS Scenario

4. PHY Mechanisms for High Efficiency

4.1. Beamforming

The 802.11ax will employ an explicit beamforming procedure, similar to that of 802.11ac. In 802.11ac access points have been equipped with omnidirectional antennas, which are so named because they send energy in all directions. Frequently, omnidirectional coverage will be shown as a circle on an overhead-view map, centered on the AP. An alternative method of transmission is to focus energy toward a receiver, a process called *beamforming*. Provided the AP has sufficient information to send the radio energy preferentially in one direction, it is possible to reach further. The overall effect is illustrated in Figure 11. Beamforming focuses energy towards a client, such as to the laptop computer at the right side of the figure. The wedges illustrate the areas where the beamforming focus increases power, and therefore the signal-to-noise ratio and data rates. The mirrored preferential transmission to the left is a common effect of focusing energy in a system with limited antenna elements. However, focusing energy towards the left and right sides of the figure means that the AP's range in other directions is smaller.



Beamforming increases the performance of wireless networks at medium ranges. At short ranges, the signal power is high enough and the SNR supports the

maximum data rate. At long ranges, beamforming does not offer a substantial gain over an omnidirectional antenna, and data rates will be identical to non-beamformed transmissions. Beamforming works by improving what is called the *rate over range* at a given distance from the AP, therefore a client device will have better performance. One way to illustrate the improved performance is shown in Figure 12. Range from the AP increases to the right and the distance from the left edge of the figure is meant to roughly approximate the range of that data rate.

Beamforming uses antenna arrays to dynamically alter the transmission pattern of the AP. The transmission pattern can be changed on a per-frame basis. Broadcast and multicast traffic is designed to be received for multiple stations, so a beamforming AP will use traditional omnidirectional transmission methods for broadcast packets to maintain coverage throughout the designed coverage area.

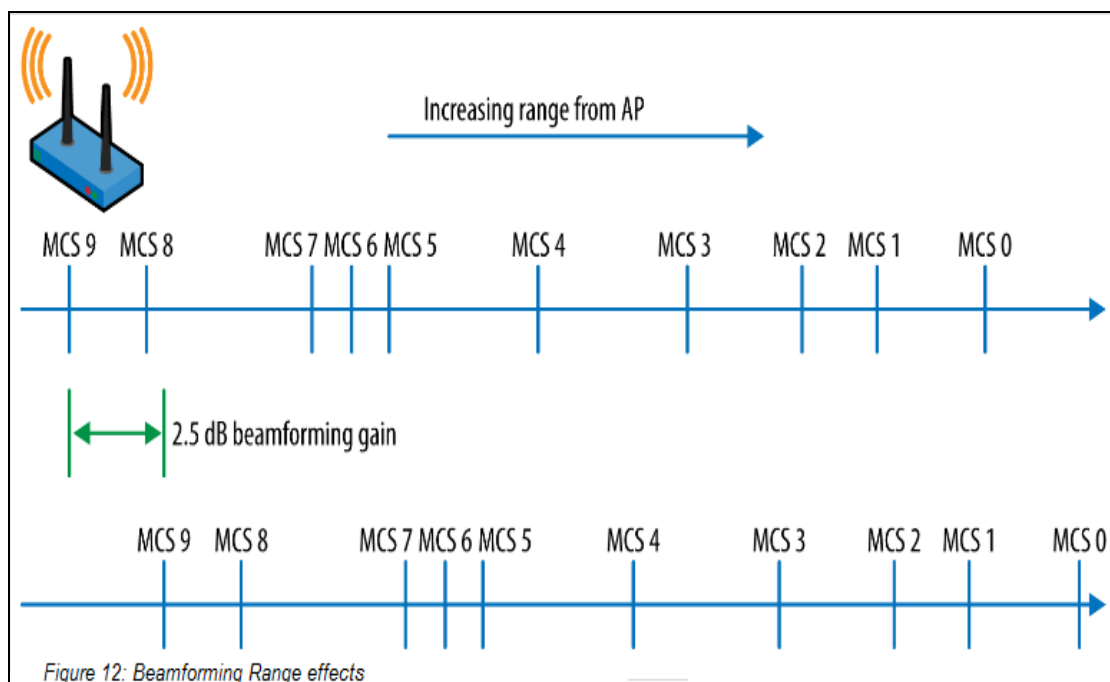

Figure 12: Beamforming Range effects

4.2. Multi-User MIMO

Multiple-input multiple-output (MIMO) is a technique to increase the wireless link capacity by exploiting multipath signal propagation and using multiple transmit and receive antennas. When transmit and receive antenna arrays are spaced apart far enough, the multipath fading that a transmitted signal encounters, differs from one transmit-receive antenna pair to another.

As illustrated in the Figure 12, for a MIMO channel with N_t transmit antennas and N_r receive antennas, the input and output relationship can be described by

$$y = H^T x + n,$$

where:

$x = [x_1, \dots, x_{N_t}]^T$ is the vector of symbols transmitted by the N_t transmit antennas

$y = [y_1, \dots, y_{N_r}]^T$ is the vector of symbols received by the N_r receive antennas

$n = [n_1, \dots, n_{N_r}]^T$ is the noise vector

H is an $N_t \times N_r$ matrix of channel gains.

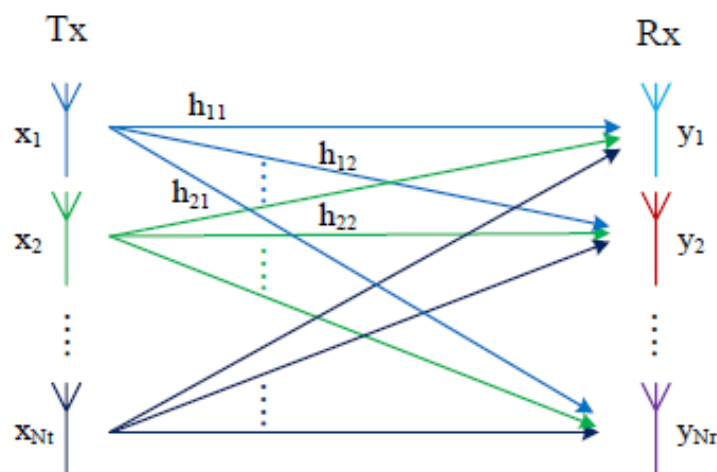

Fig.12 MIMO channel model with N_t transmit antennas, N_r receive antennas, and channel gain h_{ij} between the i^{th} transmit antenna and the j^{th} receive antenna

The difference in channel quality between pairs of transmit-receive antennas is utilized either to improve the reliability of signal transmission or to simultaneously transmit independent data streams from different transmit antennas, also known as spatial multiplexing.

In spatial multiplexing, if the transmitter has N_t transmit antennas and the receiver has N_r receive antennas, the maximum number of data streams is $N_s = \min(N_t, N_r)$. Therefore, the data rate will increase by a factor of N_s , as compared to using a single antenna at the transmitter and a single antenna at the receiver, i.e., single-input single-output (SISO).

The advantages of MIMO come at the cost of requiring more complex signal processing and channel state information (CSI) at the transmitter and/or receiver. In an open-loop MIMO system, the CSI is not available at the transmitter, and the receiver uses the CSI to decode the transmitted vector, x , based on the received vector y .

On the other hand, in a closed-loop MIMO system, the CSI is available at the transmitter and is used to pre-code the transmitted symbols. The capacity gains of different open-loop and closed-loop MIMO systems are analyzed in.⁸

In a single-user MIMO (SU-MIMO) system, the transmission is between a single transmitter and single receiver that have multiple transmit and receive antennas. On the other hand, in a MU-MIMO system, the available antennas are spread over multiple independent transmitters and receivers.

MU-MIMO leverages the spatially distributed user locations to achieve a spatial multiple access gain, which is useful when the number of STAs is large and the number of antennas at the AP is more than the number of antennas at each STA.

In addition, MU-MIMO is more immune to signal propagation issues that degrade the SU-MIMO performance, such as antenna correlations or channel rank loss. MU-MIMO can be categorized into MIMO broadcast channels (MIMO-BC) and MIMO multiple access channels (MIMO-MAC). MIMO-BC refers to simultaneous

⁸ A. Goldsmith, S. A. Jafar, N. Jindal, and S. Vishwanath, "Capacity limits of MIMO channels," IEEE J. Selected Areas in Communications (JSAC), vol. 21, no. 5, pp. 684–702, 2003.

transmission from a single AP to multiple STAs using spatially multiplexed downlink streams, while MIMO-MAC refers to simultaneous transmission from multiple STAs to a single AP using spatially multiplexed uplink streams. Unlike SU-MIMO systems, most of the MIMO-BC schemes require CSI to be available at the transmitter AP. Obtaining CSI at the transmitter side is generally more costly than at the receiver side, due to the requirements of feedback messages from the receiver. However, MIMO-MAC requires CSI only at the receiver AP, which costs less in signaling overhead, as compared to MIMO BC.

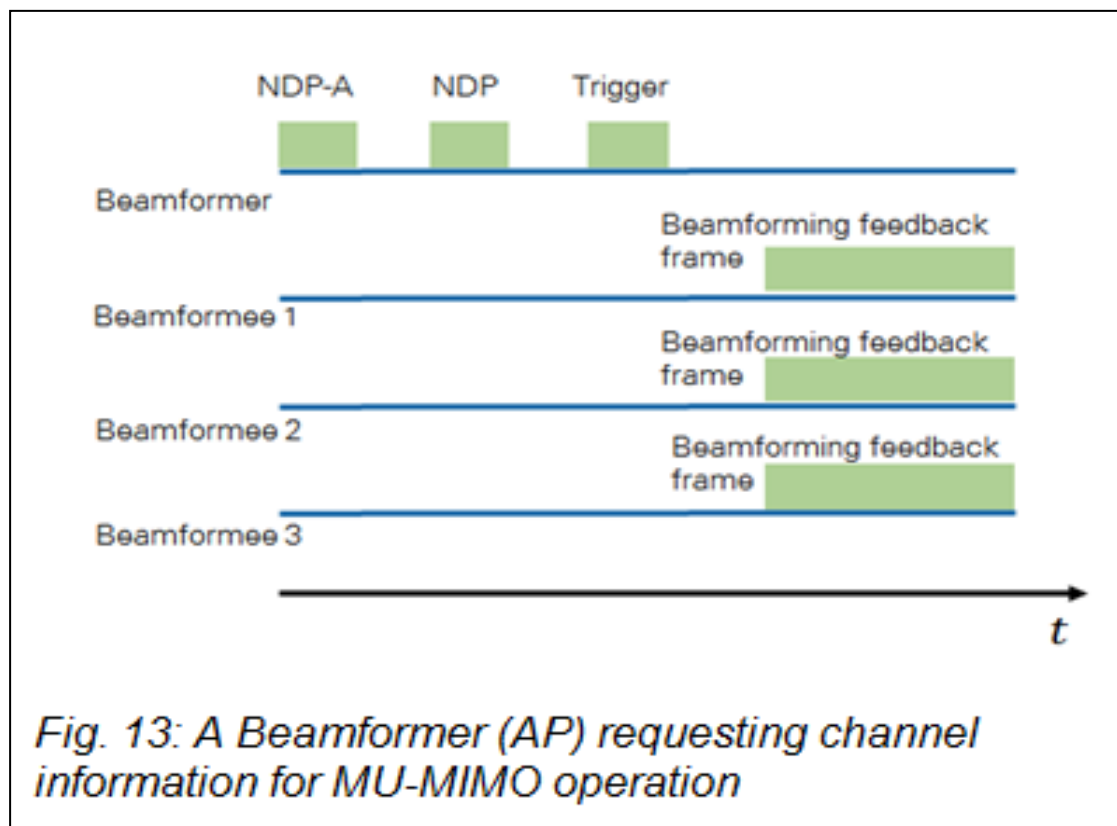

Fig. 13: A Beamformer (AP) requesting channel information for MU-MIMO operation

In the IEEE 802.11n amendment, a limit of up to four downlink SU-MIMO data streams is allowed between an AP and a STA⁹. The maximum number of simultaneous downlink streams of SU-MIMO is increased to eight in the IEEE 802.11ac amendment¹⁰. Moreover, the IEEE 802.11ac provides simultaneous data

⁹ IEEE standard for information technology–telecommunications and information exchange between systems local and metropolitan area networks–specific requirements part 11: Wireless LAN medium access control (MAC) and physical layer (PHY) specifications,” pp. 1–2793, Mar. 2012.

¹⁰ “IEEE standard for information technology– telecommunications and information exchange between systems local and metropolitan area networks– specific requirements–part 11: Wireless LAN medium access control (MAC) and physical layer (PHY) specifications–amendment 4: Enhancements for very high throughput for operation in bands below 6 GHz,” pp. 1–425, 2013.

streams for up to four downlink MU-MIMO STAs (i.e., MIMO-BC). For HEW, adopting uplink MU-MIMO (i.e., MIMO-MAC)¹¹ and employing a large number of antennas. (Massive-MIMO)¹² are currently proposed by the IEEE 802.11ax task group.

4.3. Orthogonal Frequency Division Multiple Access (OFDMA).

The IEEE 802.11ax protocol to multiplex multiple users in the same channel bandwidth, borrows from the 4G cellular technology advanced mechanism OFDMA (Orthogonal Frequency Division Multiple Access). Based on the mechanism ancestor, OFDM (Orthogonal Frequency Division Multiplexing, the IEEE 802.11ax delegates more specific sets of sub-carriers to individual users. It divides the existing channels (width 20MHz, 40MHz, 80MHz, 160MHz) into smaller sub-channels, with a predetermined number of sub-carriers.

Another technology that lends characteristics in OFDMA is LTE (Long Term Evolution). The new protocol uses the smallest sub-channel of about 26 sub-carriers the least, and called Resource Unit-RU.

On the basis of the "traffic needs" the AP decides how to channel available always instructing all RUs available for downlink. It may delegate the whole channel to a single user at a time (As IEEE 802.11ac) or it can be divided in order to serve many users simultaneously (Figure 15). In dense environments, where many users would normally claimed to no avail, the OFDMA serves simultaneously a smaller but exclusively to those sub-channel, thereby improving average throughput per

¹¹ IEEE 802.11-13/1154r1, "DL-MU-MIMO transmission with unequal Bandwidth", 2013

¹² IEEE 802.11-13/1046r2, "Discussion on massive MIMO for HEW", 2013.

In the uplink (uplink), the OFDMA solves the same problems, as well as improves the range of channels simultaneously. This is achieved, since the energy of each station is concentrated in a narrower noise bandwidth.

The requirements of next-generation WLANs shows OFDMA mechanism based on a multiuser MAC protocol. The frame consists of three parts as shown in the Figure 16:

1. *Multiuser channel access,*
2. *Multiuser resource scheduling*
3. *Multiuser data transmission.*

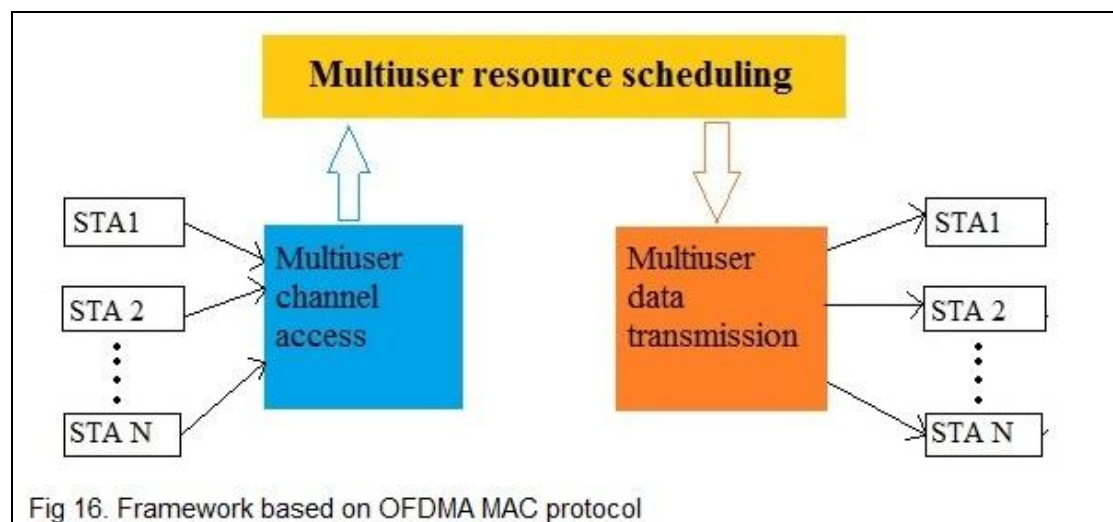

Fig 16. Framework based on OFDMA MAC protocol

Multiuser channel access

To reduce the probability of collision and thereby to improve the channel efficiency, a number of stations will be able to access instant using OFDMA. The idea of simplicity and flexibility in the IEEE 802.11 Distributed Coordination Function (DCF) should be adopted in the process of a multiuser channel and need not to add excessive signaling. It is best for the stations to convey service information as well as information on the status of the channel, during the channel access would help the AP to allocate channel resources.

Multiuser resource scheduling

After the completion of the requests for access to the channel, service information, and information on the state of the channel, the AP needs to plan their channel resources successfully in all the stations. The two main objectives of the different services of the program are to meet the QoS (Quality of services -Quality services) and achieve multiple diversity. Since the mobility of the node is small, the coherence bandwidth is greater than the WLANs in LTE and WiMax systems. Thus, the size of the programming of resources in next generation WLANs should be relatively large.

Multiuser data transmission

All programmed stations can transmit data several times in a TXOP. Each data transmission should be a group of stations, which share instantaneous transmission. A group of stations may transmit at the same time using the OFDMA mechanism.

Nevertheless, there are two major challenges for the implementation of the new OFDMA WLANs generation, synchronization and signaling burden. Timing is one of the most important issues in the OFDMA technology, since the OFDM system is sensitive to synchronization errors. The AP will successfully receive multiple packets from multiple stations only if these stations are synchronized. To ensure that multiple stations have access to the channel and can transmit simultaneously further signaling. However, additional signaling means degradation of system performance¹³.

To conclude, in order to design a promising MAC protocol, issues such as the synchronization and signaling burden, should be taken seriously. The proposed OFDMA based multiple access is on the IEEE 802.11ax (OFDMA based multiuser access for IEEE802.11ax - OMAX).¹⁴

¹³ Li, Bo, et al. "Survey on OFDMA based MAC protocols for the next generation WLAN." Wireless Communications and Networking Conference Workshops (WCNCW), 2015 IEEE. IEEE, 2015

¹⁴ Qu, Qiao, et al. "An OFDMA based concurrent multiuser MAC for upcoming IEEE 802.11ax." Wireless Communications and Networking Conference Workshops (WCNCW), IEEE, 2015

5. Performance Evaluation 802.11ac/ax

In this Chapter, we evaluate the performance of the 802.11ax wireless local area network systems. The next generation of 802.11 very high throughput wireless local area network systems is on development. This new standard promises to provide up to 10 Gbps.

The 802.11ac standard uses orthogonal frequency division multiplexing (OFDM) and multiuser multiple input multiple output (MU-MIMO) Technologies. The multi-user MIMO technology of 802.11ac will use it in 802.11ax. MU-MIMO in 802.11ac/ax promise to deliver high multi-station throughput for use with the ever-increasing demand of wireless connectivity. Also allows simultaneous transmission from one access point (AP) to multiple stations (STA) in contrast to the time sharing nature of carrier sense multiple access (CSMA), more than one client receive packets at the same time from Access Point (AP) leading the frequency reuse of the available spectrum and hence better system performance.

The MU-MIMO introduces multiple spatial streams (SS) distributed between the clients. Multiple Clients can be serviced simultaneously; hence, congestion delay is not an issue. The presence of MU-MIMO feature is more obvious when multiple clients are present in sports stadium or auditoriums, in hotspots and in other large enterprises.

5.1 Modifications to the WLAN standard have been studied to PHY layer.

- 1) Transmission and reception of MU data streams: The overall block diagram of 802.11ac PHY layer for supporting MU-MIMO is shown in **Figure-17**.

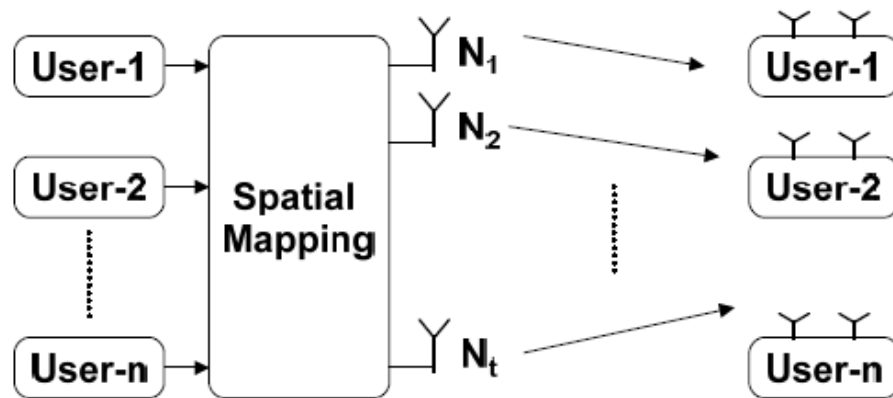
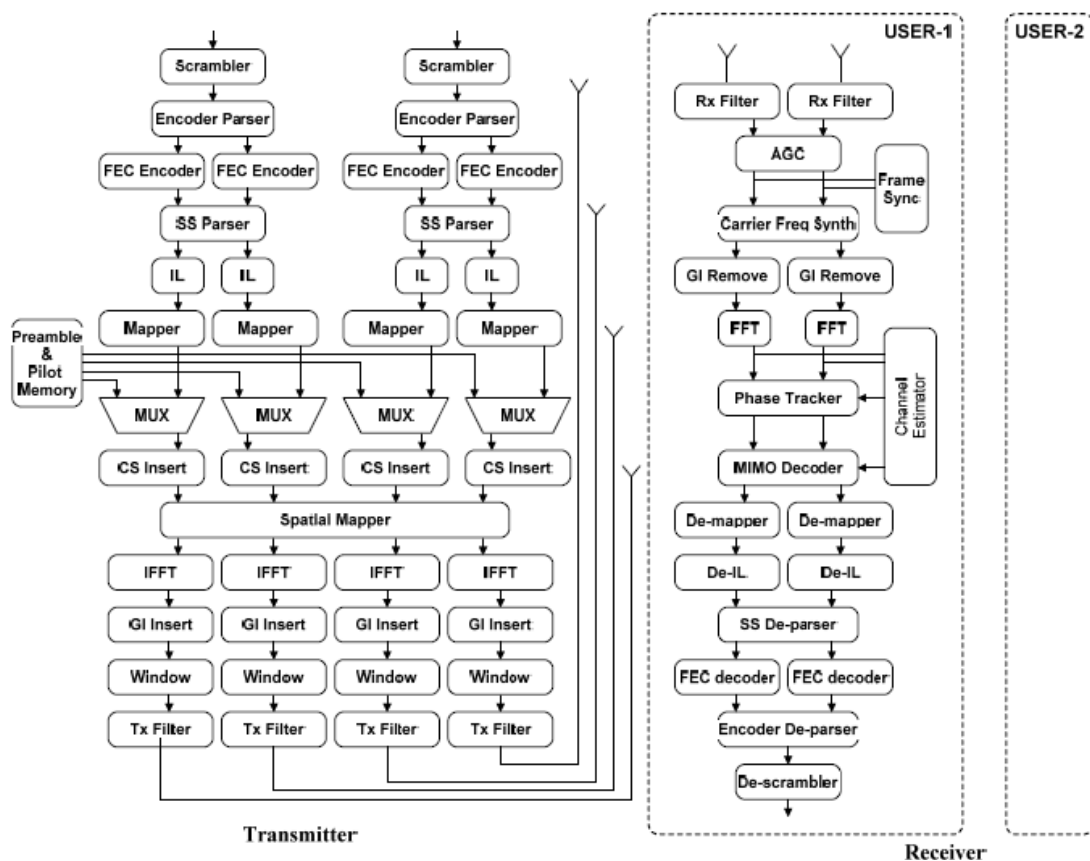

Figure-18 shows a simplified block diagram of a 2 user MIMO system.



- Transmitter Structure

Refer figure-18. During transmission, 802.11ac processes each user independently until the analog front end in the spatial mapper where these signals get joined. At this point, the steering matrix is applied.

- Receiver Structure

The **figure-18** can be used while referring receiver details in the sections which follow.

- 2) VHT Packet Format: The packet format of 802.11ac is shown in Figure-7. The non-shaded area is always single stream, is transmitted omnidirectionally while the shaded area is generally multi-stream, and is precoded for downlink MU-MIMO beamforming.

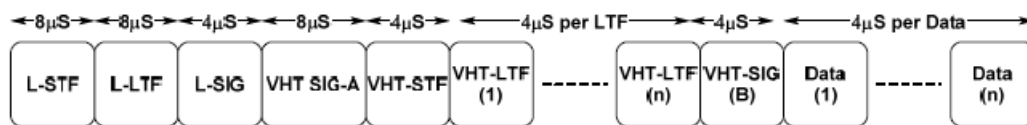

Legacy fields (LSTF,L-LTF and L-SIG) are all used for compatibility with legacy 11a/n devices.

VHT-STF: Used for MIMO data power computation.

VHT-LTFs: Used to compute the MIMO Channel. This information is either sent back to the AP during sounding or used for symbol detection when receiving a MU transmission.

VHT-SIG A: Used in MU-MIMO beamforming to inform the participating STAs of the parameters of the directional portion of the packet.

VHT-SIG B: Information regarding user specific modulation and coding rates schemes (MCS) and per user DATA field lengths.

- 3) Channel calibration/Sounding for MU-MIMO: Here, Channel State Information (CSI) is obtained from all related users, with the aim of identifying beamformees with orthogonal channel vectors. This results in total suppression of interference between the multiple streams directed towards the various users.

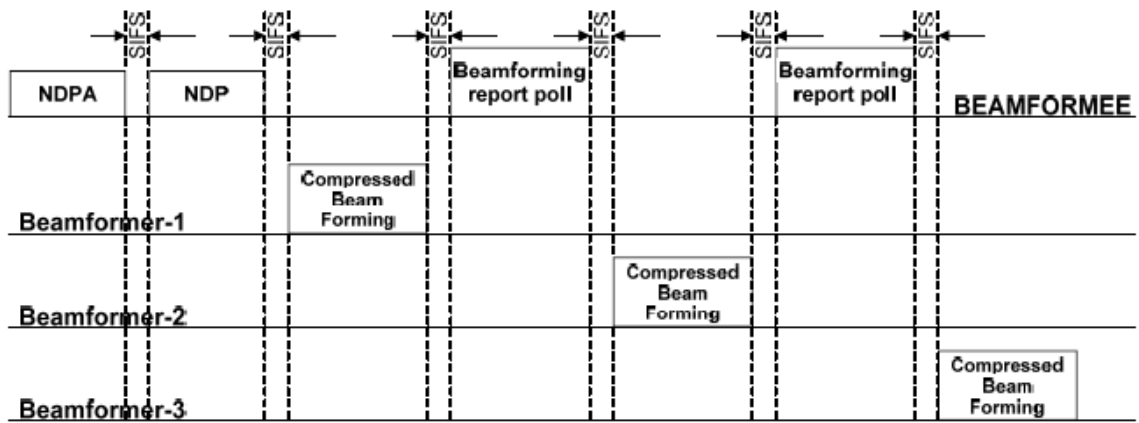
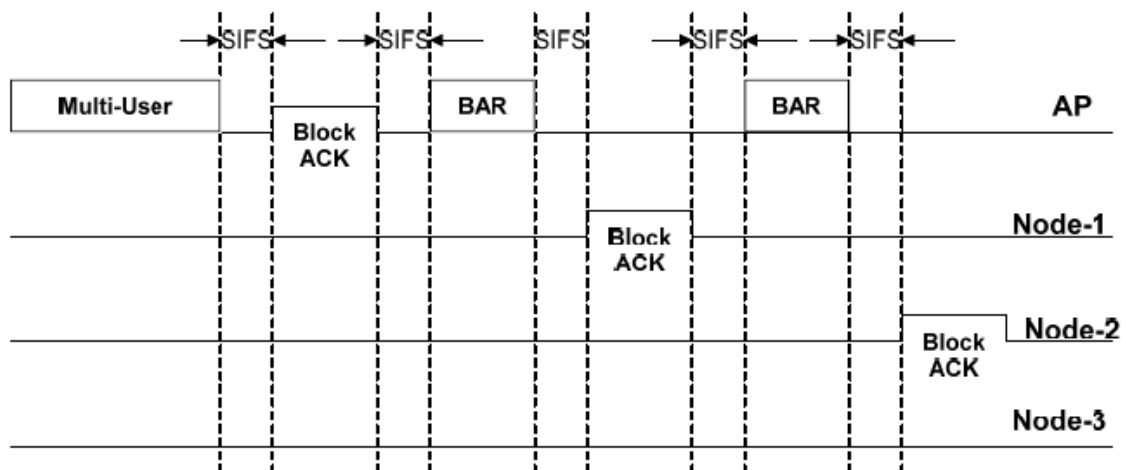

Figure-19 shows the channel sounding and MU-MIMO transmission protocols defined in IEEE 802.11ac. When the AP performs channel sounding at a given time, it announces the beginning of a sounding process by transmitting a null-data packet announcement (NDPA). After a short inter frame space (SIFS), the AP transmits a null-data packet (NDP), in which each AP antenna sequentially transmits a known signal for channel estimation. As shown in the figure, the multi-user mechanism necessitates a response from all beamformees, for which purpose, the Beamforming report poll frame is added. After a SIFS, a predestinated node feeds back the CSI. After a SIFS again, the AP polls a next node, and the polled node feeds back the CSI after a SIFS until there is no remaining node to be polled for CSI feedback. The multiple responses are combined by the beamformer resulting in a master steering matrix. The NDP announcement frame, NDP frame and compressed beamforming action frame are same as in Transmit Beamforming. The 802.11ac MAC protocol defines capability (number of SS, MCS) negotiation for all the transmissions happening in parallel.



After the AP transmits packets to the primary and secondary users, the primary user transmits a block acknowledgement (BA) after a SIFS. Then, the AP transmits a BA request (BAR) for one of the secondary users after a SIFS, and the polled node transmits a BA after a SIFS until there is no remaining node to be polled. This is shown in figure-9.

4) Precoding: Precoding techniques play a major role in the performance of MU-MIMO transmission. In this regard, there are two major classes of precoding namely, non-linear and linear precoding. Non-linear precoding techniques are recognized to be useful for obtaining the maximum throughput possible. Some of these non-linear precoding techniques are Tomlinson-Harashima precoding (THP), Vector Perturbation (VP) and Lattice Reduction Aided (LRA) methods. However, these techniques have a very high level of complexity caused by the requirement of additional processing at the receiver and are not supported by 802.11ac. Linear precoding techniques (Dirty Paper Coding (DPC), Zero Forcing and Block Diagonalization (BD)) on the other hand are low-complexity transmission techniques and are supported by 802.11ac. For a Gaussian MIMO channel, DPC can achieve the highest capacity region. The sum capacity in a MIMO broadcast channel is the capacity aggregation of all the users. Although DPC can achieve the maximum gain, it is more of a theoretical concept and real time implementation of DPC is very complex. Zero forcing technique for MU-MIMO, does not require the channel information of other users and uses the pseudo inverse of the current user channel. Although this method is uncomplicated compared to BD, it is suboptimal in the sense that it does not nullify the inter user interferences effectively. However, at lower SNR cases, this algorithm works better than BD. BD, an extension of zero forcing precoding for MU-MIMO systems is a simple algorithm that can reach a sum capacity comparable to that of DPC - with an implementation that is much easier than DPC. Here, each user's precoding matrix lies in the null space of all the other users' channels. If the channel matrices are perfectly known at the transmitter, then there is no interference at each receiver.

5) User selection: Since total numbers of users are generally more than the number of users which can be supported at the AP, optimal users with good CSI can be

selected to improve the throughput of MU-MIMO system. The most favorable user can be identified by extensive investigation, although it necessitates computational complexity as the number of users increases. Greedy user selection, an algorithm with less complexity, chooses one user at each iteration. Complexity and performance of the algorithm depend on the user selection metrics such as Frobenius norm (FN) or Chordal distance (CD).

6) Detection Mechanisms: Additionally, at the receiver side, the independent signals will need to be separated by using a technique called MIMO detection. Traditional MIMO detection methods include the well-known linear MMSE as well as the vertical-Bell laboratories layered space-time (V-BLAST) and LRA decoders. V-BLAST and LRA techniques improve the performance of the simple MMSE-MIMO decoder. Another high

Performance MIMO detection algorithm is called the Maximum Likelihood Detection (MLD) algorithm. MLD algorithm has a very high level of complexity and are is hence impractical.

5.2 PRECODING ALGORITHMS

The transmitter computes a beamforming weight matrix that will prevent signals of one STA to interfere with other STAs. Let us consider the multiuser MIMO system where the STA has N_{TX} antennas, each STA has N_{RX} antennas, and the number of existing STAs is N_{USR} . When an $N_{RX} \times N_{TX}$ channel matrix of the i th user is defined as H_i , an $N_{RX}N_{USR} \times N_{TX}$

channel matrix can be expressed as $\mathbf{H} = [\mathbf{H}_1^T, \mathbf{H}_2^T, \dots, \mathbf{H}_i^T, \dots, \mathbf{H}_{N_{USR}}^T]^T$ (1).

\mathbf{H} follows a complex Gaussian distribution with mean zero and variance one (Rayleigh distribution). In general, the received signal of the i th user can be expressed as $\mathbf{y}_i = \mathbf{H}_i \mathbf{x} + \mathbf{n}_i$. (2)

$\mathbf{X} = [\mathbf{X}_1, \mathbf{X}_2, \dots, \mathbf{X}_i, \dots, \mathbf{X}_{N_{USR}}]^T$ is the transmit signal vector, and \mathbf{n}_i is the noise from the receiver. We assume that for each of the K users, this noise is identically distributed, independent, equal variance and zero mean Gaussian noise. Hence $\mathbf{R}_n = \mathbf{E}[\mathbf{nn}^H] = \sigma^2 \mathbf{I}$.

A. Channel Inversion

CI achieves MU-MIMO transmission by multiplying signals at access points by the inverse of the channel matrix \mathbf{H} , which represents **CSI** from AP to each STAs. The easiest precoding scheme called CI precoding is expressed as

$$\mathbf{x} = \frac{\mathbf{H}^{-1}\mathbf{u}}{\sqrt{\gamma_{CI}}}, \quad (3)$$

Where \mathbf{u} is the vector of symbols intended for the N_{USR} users while \mathbf{x} is the precoded transmit symbol vector. The denominator $\sqrt{\gamma_{CI}} = \mathbf{u}^H(\mathbf{H}\mathbf{H}^H)^{-1}\mathbf{u}$ normalizes the transmit power to a constant value. This is because the inverse of the channel matrix used as the weight matrix in CI has singular values with a wide distribution. The wide distribution of the singular values of the inverse increases the precoded signal power.

B. Block Diagonalization

BD is a generalization of channel inversion techniques when there are multiple antennas at each STAs. We first consider an $N_{RX} \times (N_{USR} - 1) \times N_{TX}$ channel matrix

$$\tilde{\mathbf{H}}_i = [\mathbf{H}_1^T, \dots, \mathbf{H}_{i-1}^T, \mathbf{H}_{i+1}^T, \dots, \mathbf{H}_{N_{USR}}^T]^T. \quad (4)$$

Let the **singular value decomposition (SVD)** of \mathbf{H}_i be

$$\tilde{\mathbf{H}}_i = \tilde{\mathbf{U}}_i \tilde{\Sigma}_i \tilde{\mathbf{V}}_i^H = \tilde{\mathbf{U}}_i \begin{bmatrix} \tilde{\Sigma}_i & \mathbf{0} \end{bmatrix} \begin{bmatrix} \tilde{\mathbf{V}}_i^b & \tilde{\mathbf{V}}_i^n \end{bmatrix}^H, \quad (5)$$

where $\tilde{\mathbf{U}}_i$ and $\tilde{\mathbf{U}}_i$ are the left singular vector matrix and the matrix of singular values of \mathbf{H}_i , respectively, and $\tilde{\mathbf{V}}_i^b$ and $\tilde{\mathbf{V}}_i^n$ denote the right singular matrices each corresponding to non-zero singular values and zero singular values ($N_{TX} - \text{rank}(\mathbf{H}_i)$) singular vectors in the nullspace of \mathbf{H}_i , respectively. $\tilde{\mathbf{V}}_i^n$ will satisfy the null constraint, since it will produce zero interference at the other users. Assuming that \mathbf{H}_i is full rank, the AP requires that the number of transmit antennas is at least the sum of all STAs receive antennas to satisfy the dimensionality constraint required to cancel interference for each STAs. The weight matrix of BD is expressed as

$$\mathbf{W}_{\text{BD}} = [\tilde{\mathbf{V}}_1^n, \tilde{\mathbf{V}}_2^n, \dots, \tilde{\mathbf{V}}_i^n, \dots, \tilde{\mathbf{V}}_{N_{\text{USR}}}^n]$$

$$\tilde{\mathbf{H}} = \begin{bmatrix} \mathbf{H}_1 \tilde{\mathbf{V}}_1^n & & & \mathbf{0} \\ & \ddots & & \\ \mathbf{0} & & \mathbf{H}_{N_{\text{USR}}} \tilde{\mathbf{V}}_{N_{\text{USR}}}^n & \end{bmatrix}. \quad (6)$$

This precoding scheme is called BD precoding and is done using

$$\mathbf{x} = \frac{\mathbf{W}_{\text{BD}} \mathbf{u}}{\sqrt{\gamma_{\text{BD}}}}. \quad (7)$$

The denominator $\gamma_{\text{BD}} = \mathbf{u}^H (\mathbf{W}_{\text{BD}} \mathbf{W}_{\text{BD}}^H) \mathbf{u}$ normalizes the transmit power to a constant value. Under the BD precoding, an effective MIMO channel can be equivalently regarded as a single-user MIMO (SU-MIMO) environment.

5.1. Intro to Simulations

In this section, we investigate the performance of linear precoding techniques based on a singular-value-decomposition (SVD) of the channel. 802.11ac supports downlink (access-point to station) multi-user transmissions for up to four users and up to eight transmit antennas to increase the aggregate throughput. Based on a scheduled transmission time for a user, the scheduler looks for other smaller packets ready for transmission to other users. If available, it schedules these users over the same interval, which reduces the overall time taken for multiple transmissions.

This simultaneous transmission comes at a higher complexity because successful reception of the individual user's payloads requires precoding, also known as transmit-end beamforming. Precoding assumes that channel state information (CSI) is known at the transmitter. A sounding packet is used to determine the CSI for each user in a multi-user transmission. Each of the users feedback their individual

CSI to the beamformer. The beamformer uses the CSI from all users to set the precoding (spatial mapping) matrix for subsequent data transmission.

The following examples use the a channel inversion technique three-user and four-user transmission with a different number of spatial streams allocated per user and different rate parameters per user. The system can be characterized by the figures below.

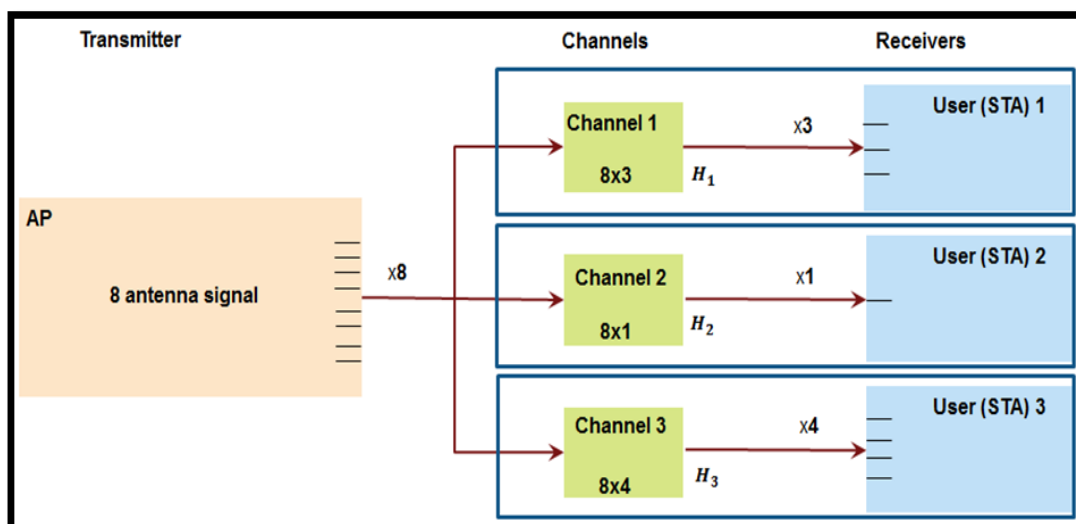
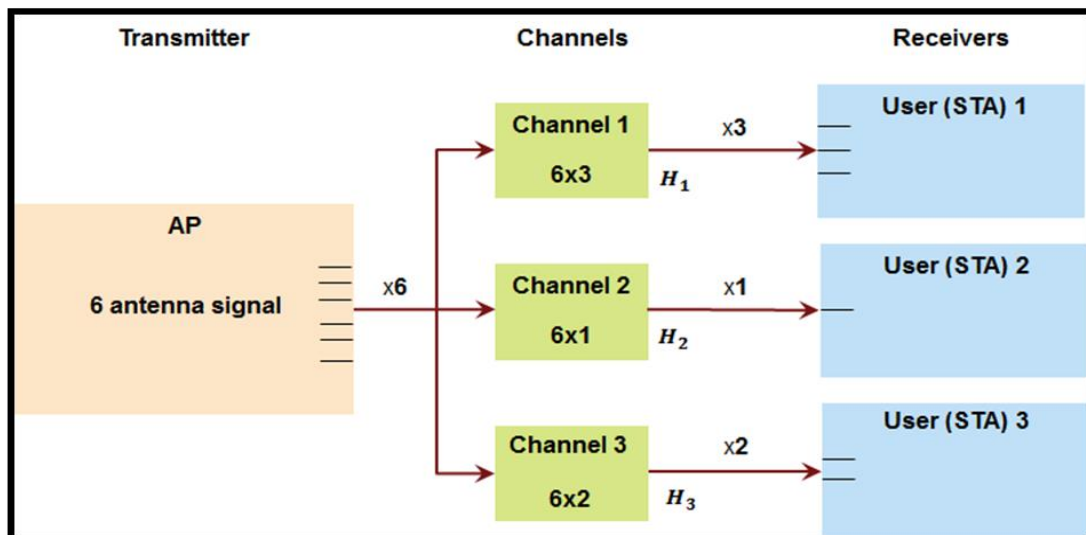

The examples generate the multi-user transmit waveform, pass them through a channel per user and decodes the received signal for each user to calculate the bits in error. Prior to the data transmission, the examples use a null-data packet (NDP) transmission to sound the different channels and determine the precoding matrix under the assumption of perfect feedback.

5.1.1 Simulation Parameters and Configuration

For 802.11ac, a maximum of eight spatial streams is allowed. An 8x8 and 6x6 MIMO configuration for three and four users are used in these examples, where are parameterized spatial streams and SNR. Different rate parameters and payload sizes for each user specified as vector parameters for the transmission configuration. The number of transmit antennas is set to be the sum total of all the used space-time streams. This implies no space-time block coding (STBC) or spatial expansion employed for the transmission.

Sounding (NDP) Configuration

For precoding, channel sounding first used to determine the channel experienced by the users (receivers). Channel state information sent back to the transmitter, for it to be used for subsequent data transmission. It assumed that the channel varies slowly over the two transmissions. For multi-user transmissions, the same NDP (Null Data Packet) is transmitted to each of the scheduled users. The number of streams specified is the sum total of all space-time streams used, so as to sound the complete channel.

Transmission Channel

The multi-user channel consists of independent single-user MIMO channels between the access point and spatially separated stations. In these examples, the same delay profile Model-A channel is applied for each of the users, even though individual users can experience different conditions. The flat-fading channel allows a simpler receiver without front-end synchronization. It is also assumed that each user's number of receive antennas are equal to the number of space-time streams allocated to them. Cell arrays are used in the examples to store per-user elements, which allow for a flexible number of users. Here, as an example, each instance of the channel per user is stored as an element of a cell array. The channels for each individual user use different seeds for random number generation. A different user index is specified to allow for random angle offsets to be applied to the arrival (AoA) and departure (AoD) angles for the clusters. The channel filtering delay is stored to

allow for its compensation at the receiver. In practice, symbol timing estimation would be used.

Channel State Information Feedback

Each user estimates its own channel using the received NDP(Null Data Packet) signal and computes the channel state information that it can send back to the transmitter. This example uses the singular value decomposition of the channel seen by each user to compute the CSI feedback. Assuming perfect feedback with no compression or quantization loss, the transmitter computes the steering matrix for the data transmission using either Zero-Forcing or Minimum-Mean-Square-Error (MMSE) based precoding techniques. Both methods attempt to cancel out the intra-stream interference for the user of interest and interference due to other users. The MMSE-based approach avoids the noise enhancement inherent in the zero-forcing technique. As a result, it performs better at low SNRs.

Data Transmission

Random bits are used as the payload for the individual users. A cell array is used to hold the PSDUs for each user. Using the format configuration with the steering matrix, the data is transmitted over the fading channel.

Data Recovery per User

The receive signals for each user are processed individually. The example assumes that there are no front-end impairments and that the transmit configuration is known by the receiver for simplicity. A user number specifies the user of interest being decoded for the transmission. This is also used to index into the vector properties of the configuration object that are user-specific.

Per-stream equalized symbol constellation plots validate the simulation parameters and convey the effectiveness of the technique. Note the discernible 16QAM, 64QAM and QPSK constellations per user as specified on the transmit end. Also observe the EVM degradation over the different streams for an individual user. This is a representative characteristic of the channel inversion technique.

5.1.2 Scenario 1

In this Scenario, there are two users in two models (Model 1-Model 2). We run the two models in MATLAB 2016b and parameterized number of antennas, Spatial Streams and SNR.

Number of users	2
Number of antennas	6,8
Spatial Streams	[1 2]
SNR	5,15,25,35,45
MCS values	U1: 4(16QAM, $\frac{3}{4}$), U2: 6(64QAM, $\frac{3}{4}$)

BIT ERROR RATE PER USER				
	6 ANTENNAS		8 ANTENNAS	
SNR	USER 1	USER 2	USER 1	USER 2
5	0.6000	0.600	0.6000	0.6002
15	0.6008	0.603	0.6008	0.6031
25	0.6009	0.602	0.6027	0.6039
35	0.025	0.604	0.0433	0.6035
45	0.001	0.539	0.001	0.5579

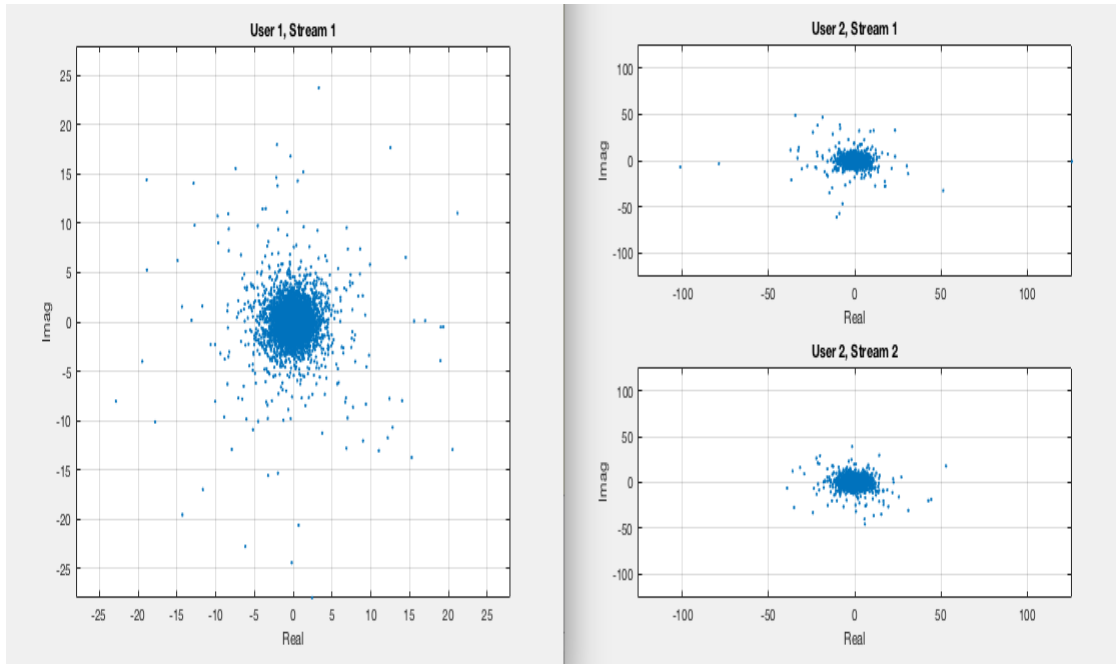

6 antennas SNR= 5

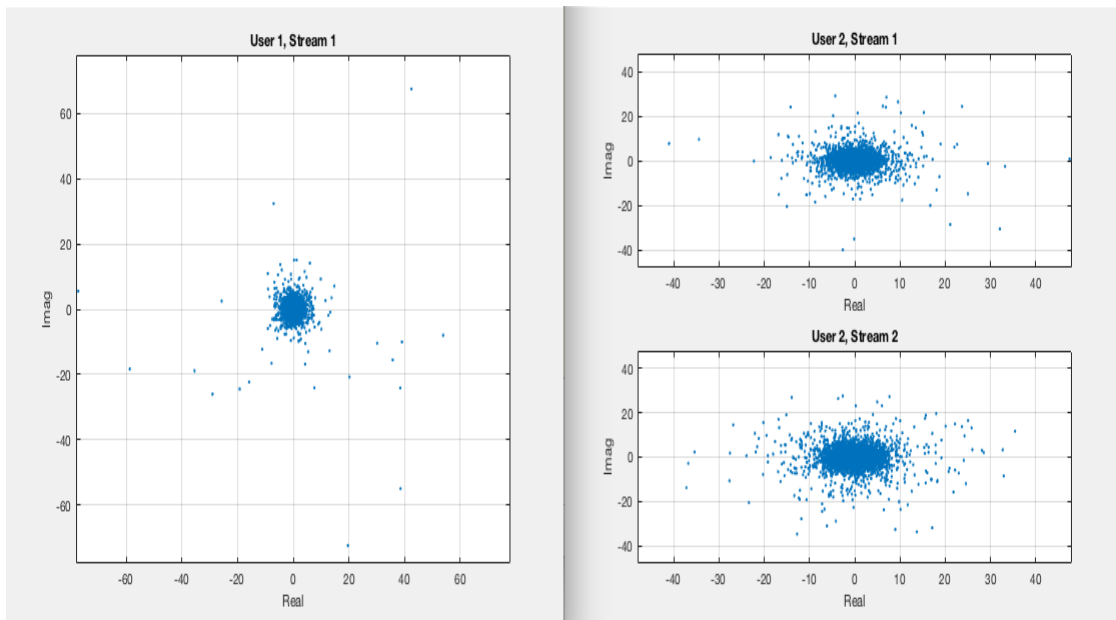

6 antennas SNR = 15

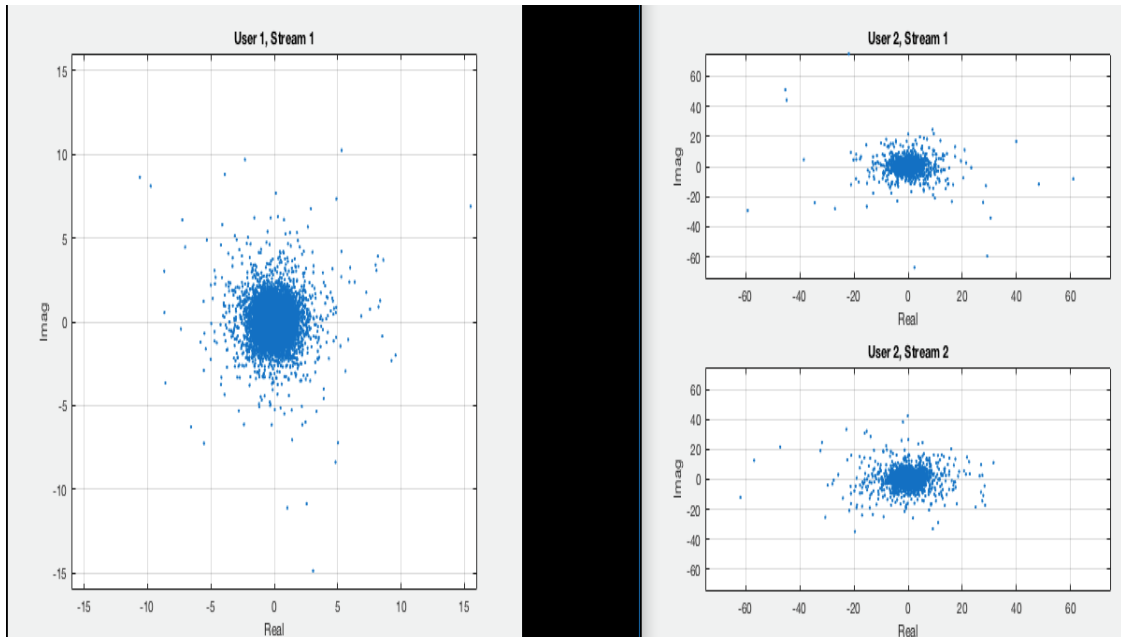

6 antennas, SNR=25

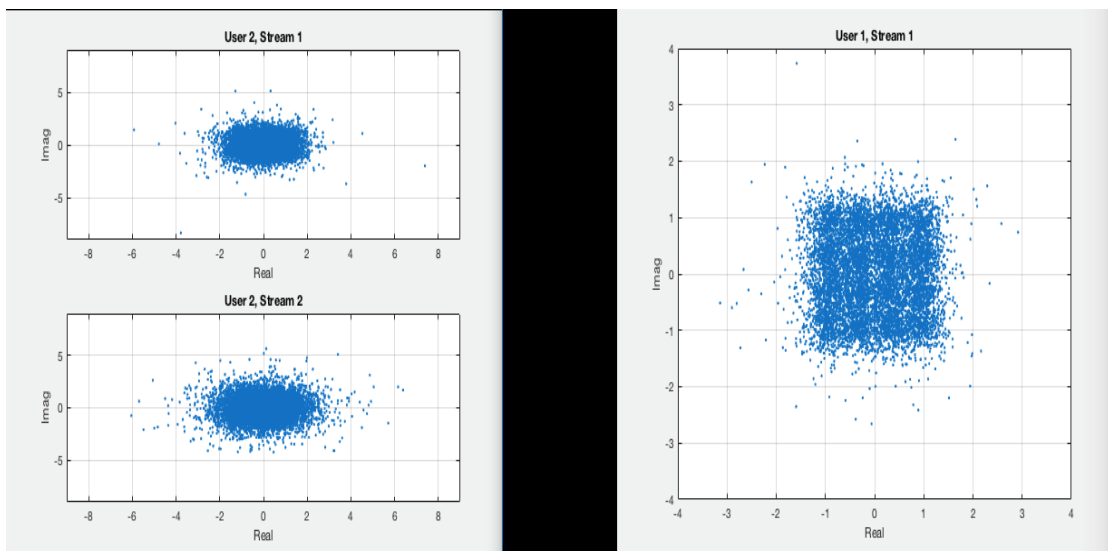

6 antennas, SNR=35

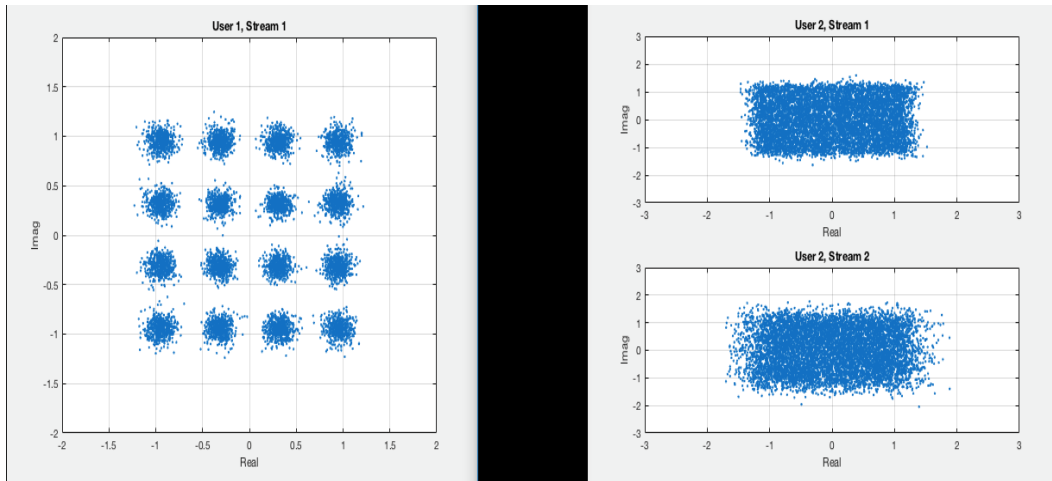

6 antennas, SNR=45

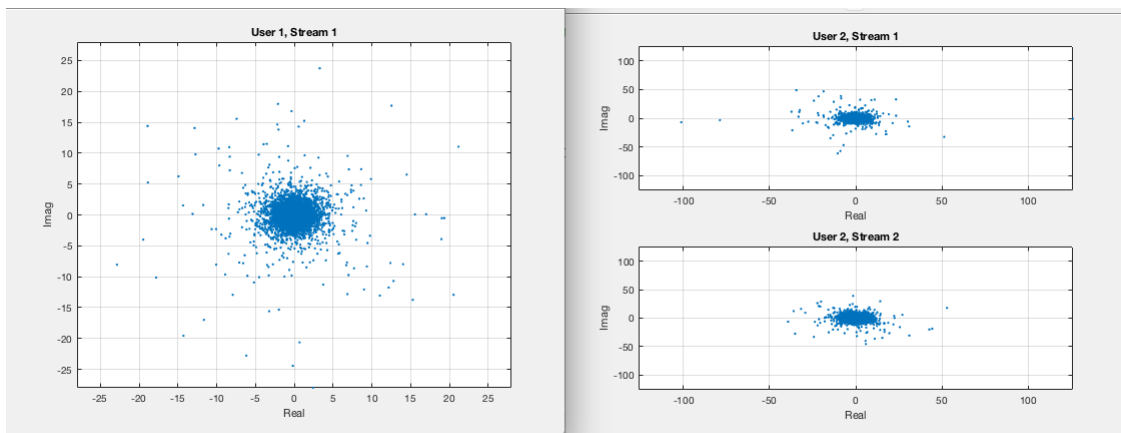

8 antennas SNR= 5

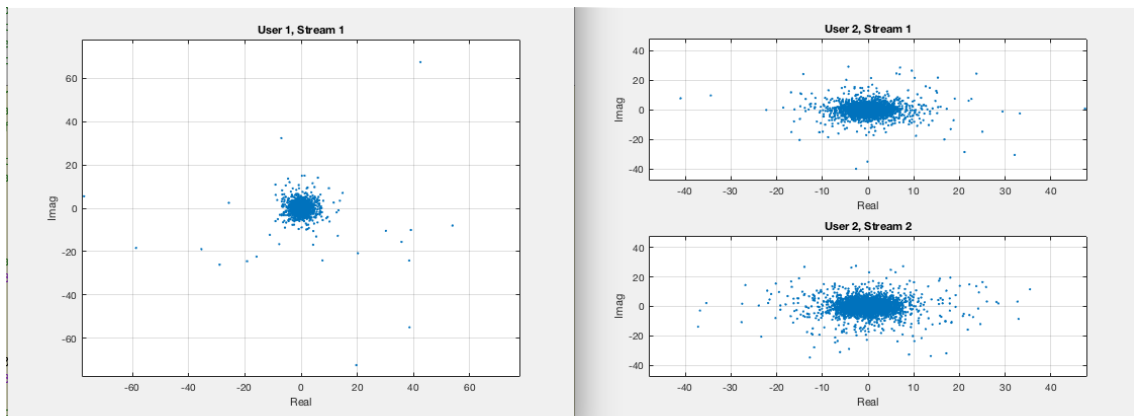

8 antennas SNR = 15

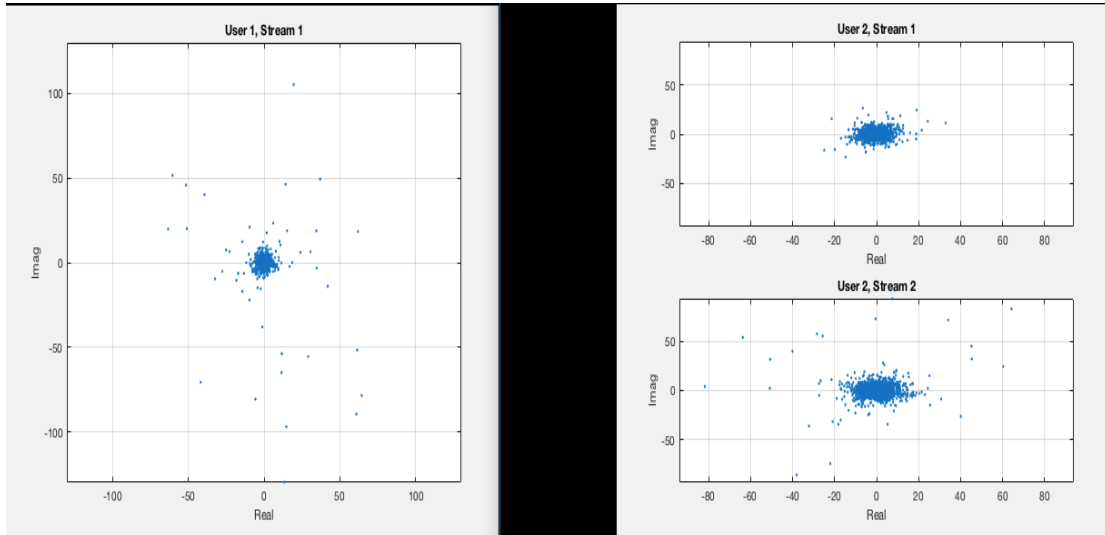

8 antennas, SNR=25

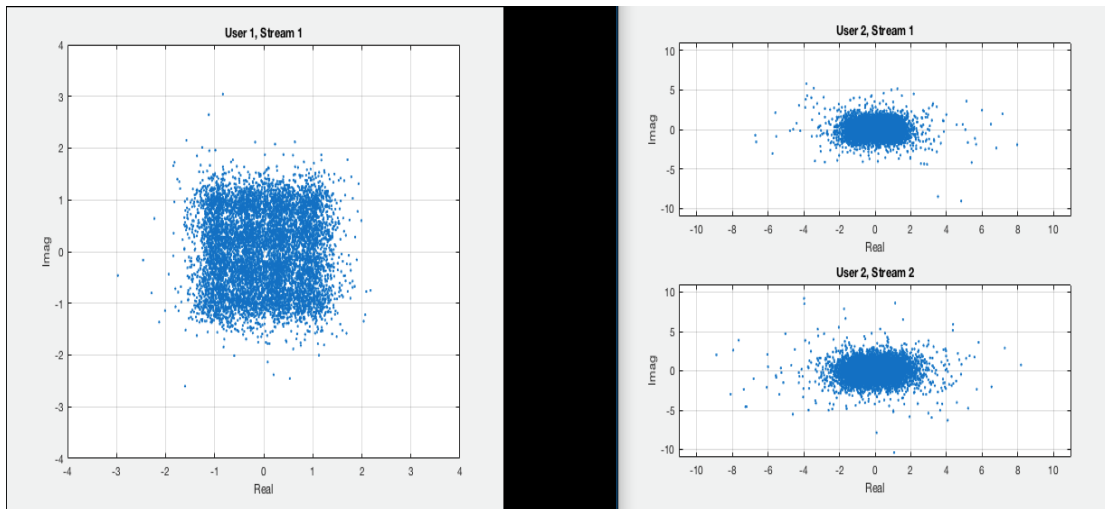

8 antennas, SNR=35

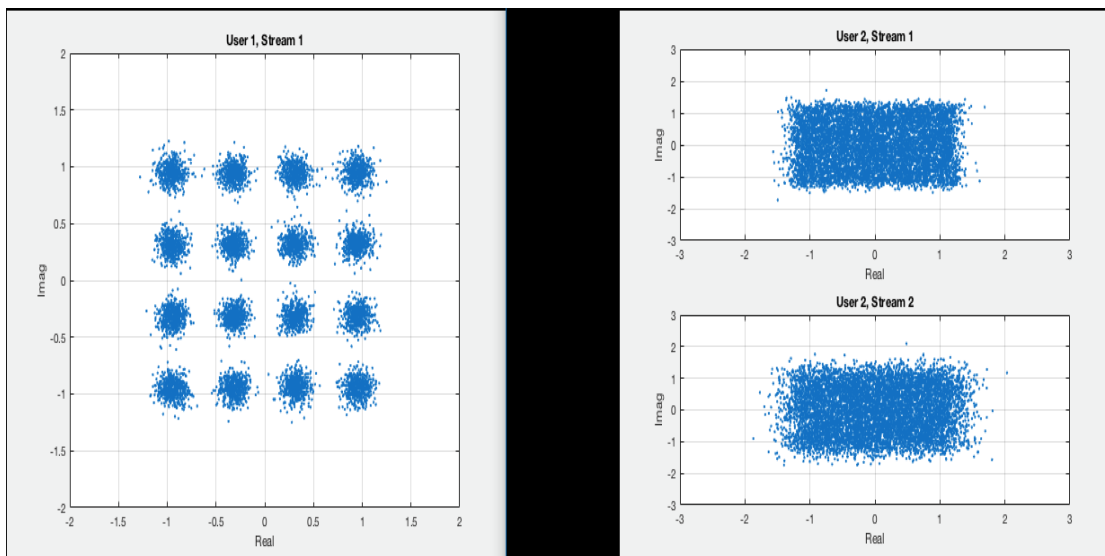

8 antennas, SNR=45

5.1.3 Scenario 2

Number of users	4
Number of antennas	6,8
Spatial Streams	[4 2 1 1]
SNR	5,15,25,35,45
MCS values	U1: 4(16QAM, $\frac{3}{4}$), U2: 6(64QAM, $\frac{3}{4}$), U3-U4: 2(QPSK, $\frac{3}{4}$)

BIT ERROR RATE PER USER								
	6 ANTENNAS				8 ANTENNAS			
SNR	User 1	User 2	User 3	User 4	User 1	User 2	User 3	User 4
5	0.608	0.600	0.605	0.692	0.6065	0.6025	0.6035	0.6809
15	0.601	0.600	0.606	0.690	0.6016	0.6035	0.6006	0.6837
25	0.5966	0.6021	0.134	0.2807	0.5966	0.6021	0.1340	0.2807
35	0.6002	0.6032	0.001	0.002	0.6012	0.6042	0.010	0.0060
45	0.0500	0.001	0.001	0.001	0.0504	0.005	0.0010	0.009

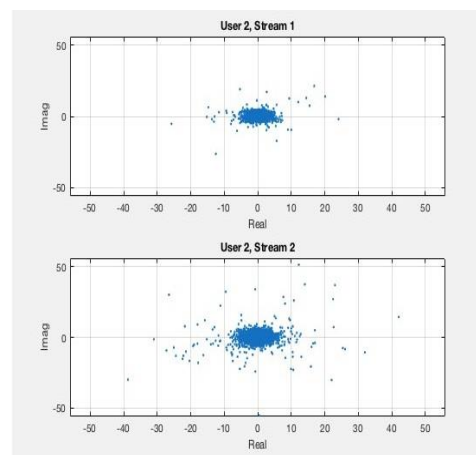
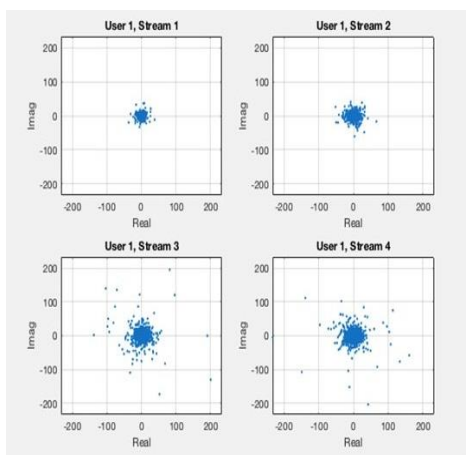

6 antennas, SNR=25

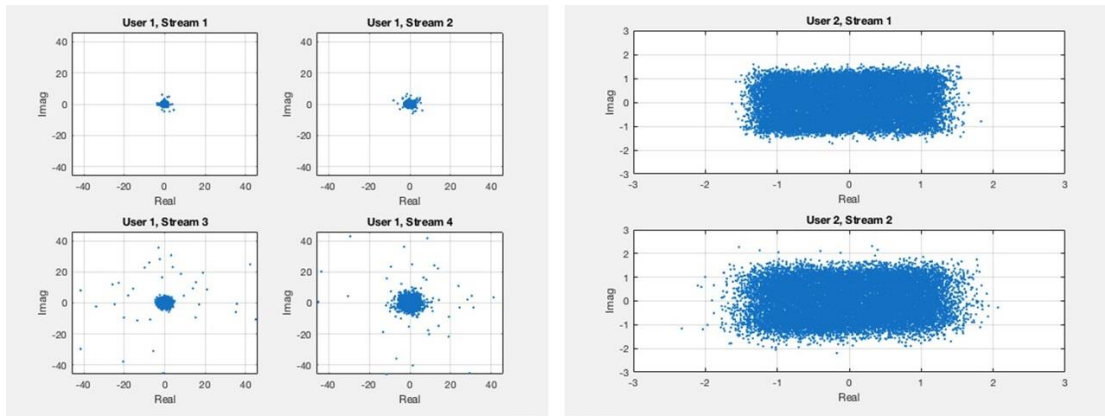

6 antennas, SNR=35

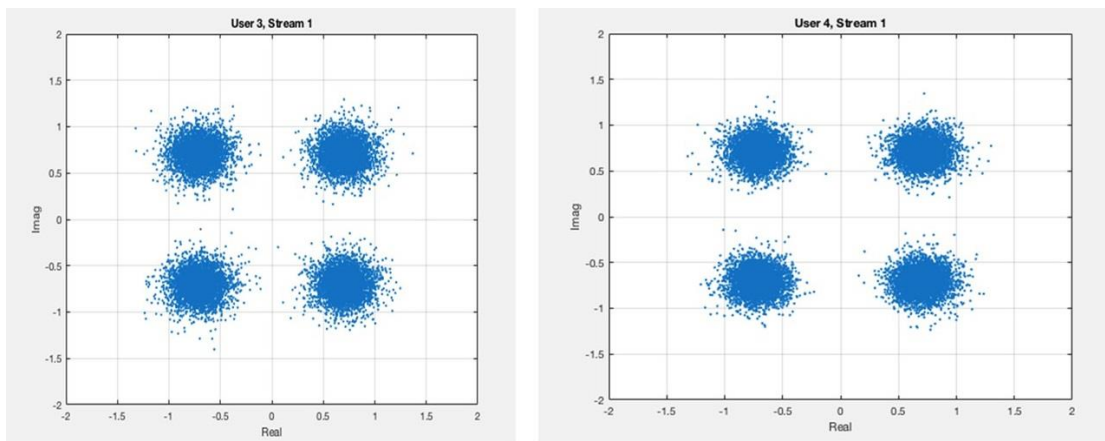

6 antennas, SNR=35

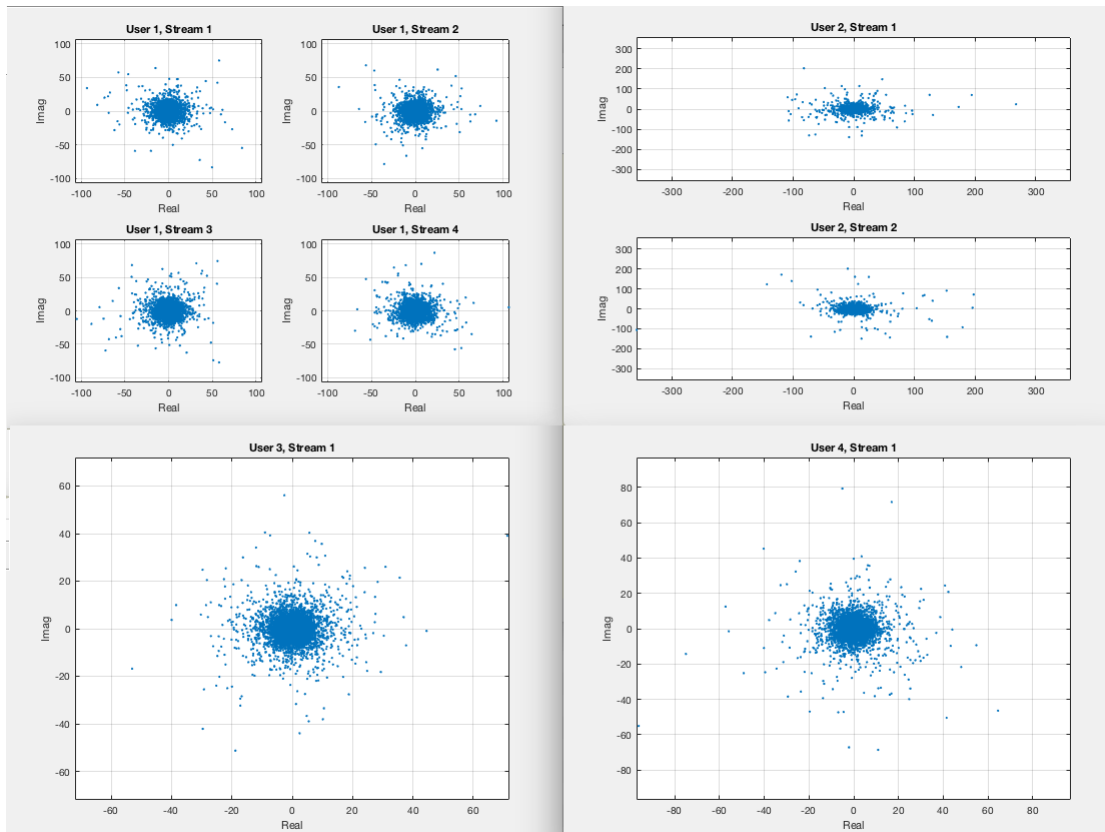

8 antennas SNR = 5

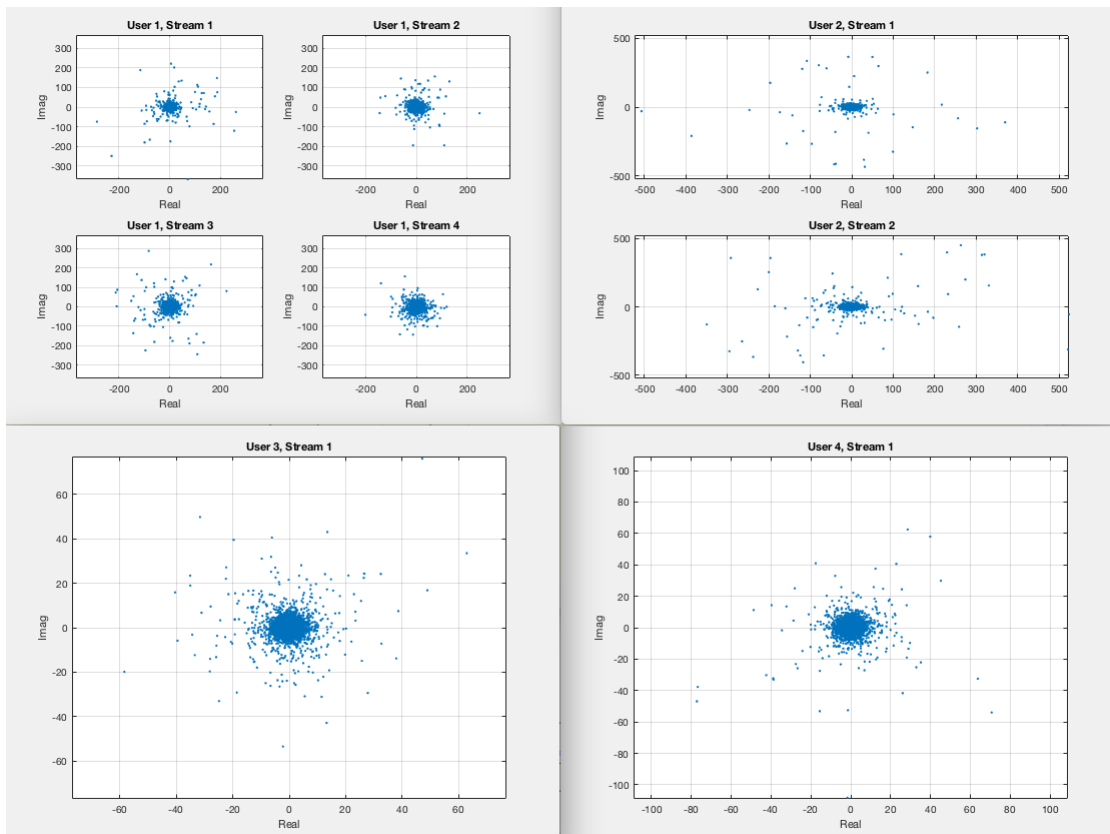

8 antennas SNR = 15

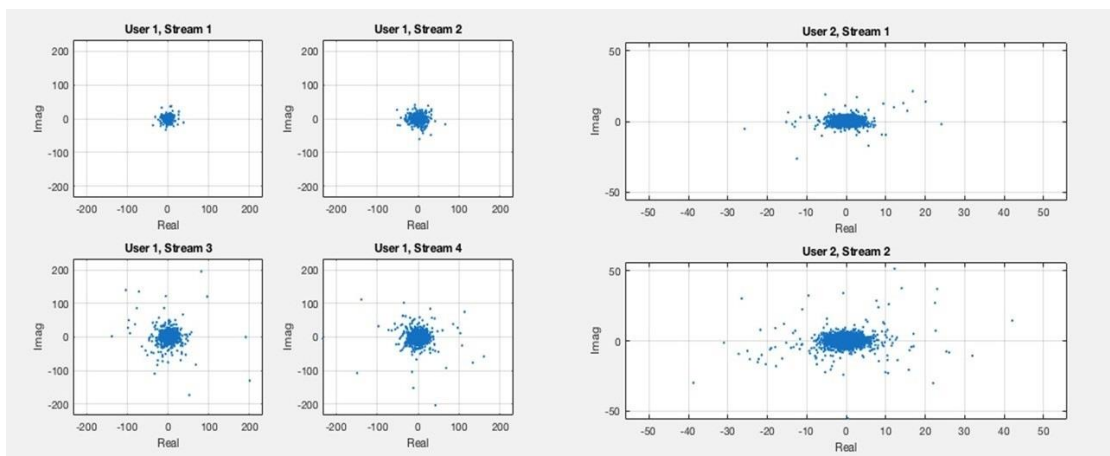

8 antennas, SNR=25

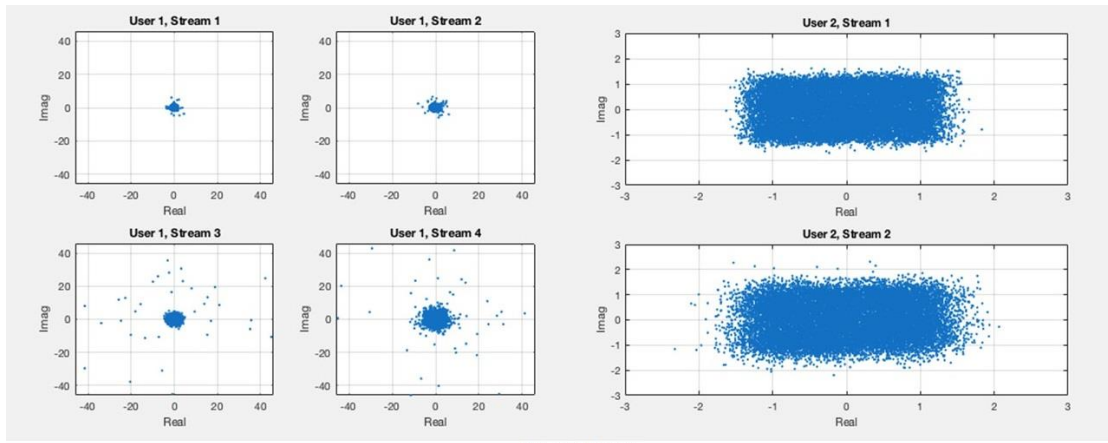

8 antennas, SNR=35

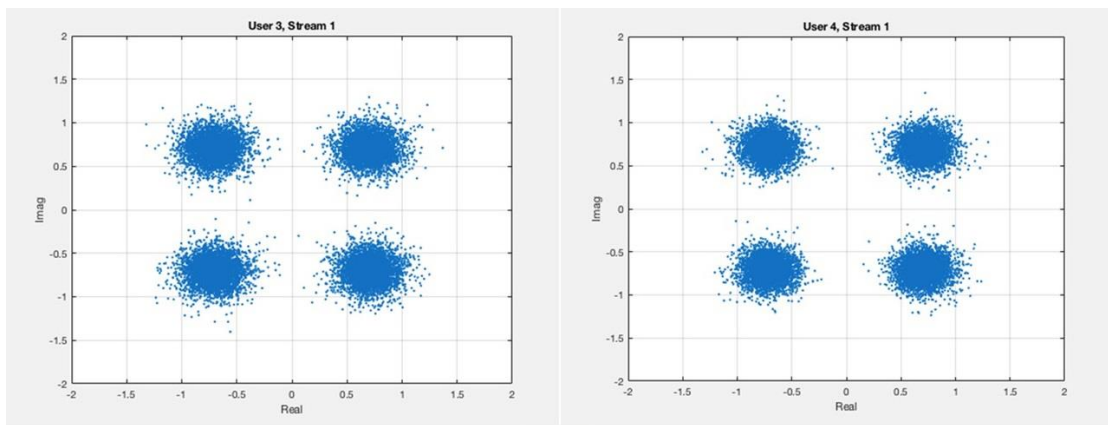

8 antennas, SNR= 45

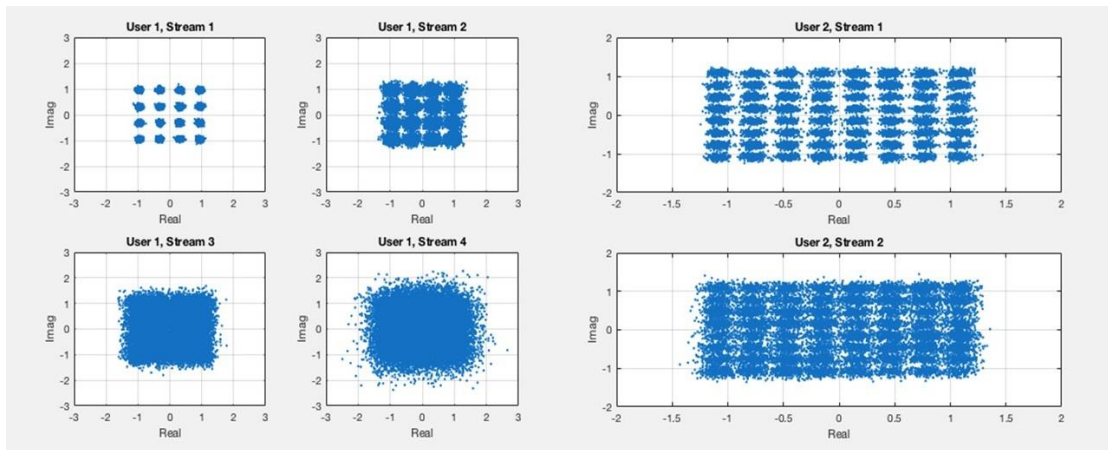

8 antennas, SNR= 45

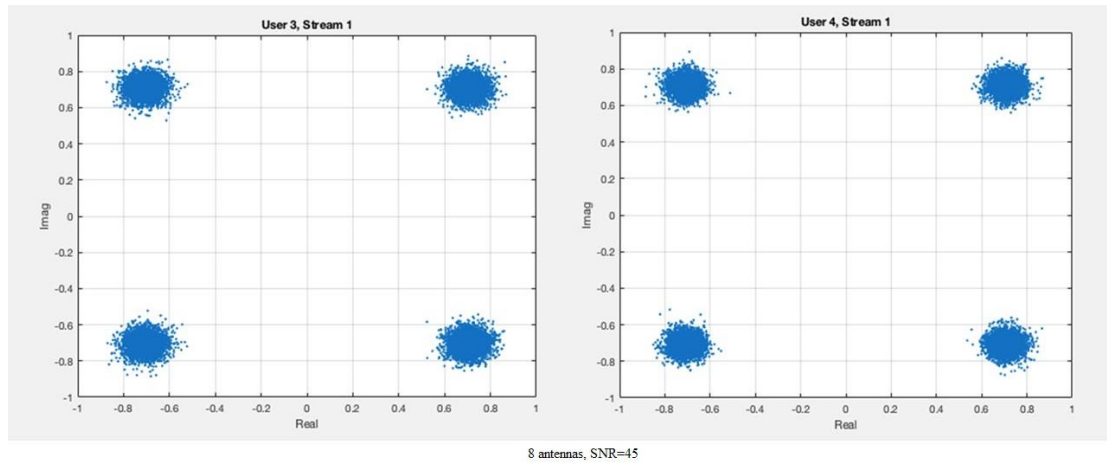

5.1.4 Scenario 3

Number of users	4
Number of antennas	6,8
Spatial Streams	[2 2 2 2]
SNR	5,15,25 35 45
MCS values	U1: 4(16QAM, $\frac{3}{4}$), U2: 6(64QAM, $\frac{3}{4}$), U3-U4: 2(QPSK, $\frac{3}{4}$)

BIT ERROR RATE PER USER								
	6 ANTENNAS				8 ANTENNAS			
SNR	User 1	User 2	User 3	User 4	User 1	User 2	User 3	User 4
5	0.625	0.600	0.605	0.692	0.625	0.600	0.605	0.692
15	0.618	0.609	0.606	0.690	0.601	0.600	0.606	0.690
25	0.600	0.601	0.586	0.686	0.600	0.601	0.586	0.686
35	0.011	0.025	0	1	0.010	0.125	0.015	0.001
45	0.001	0.002	0	0	0.001	0.005	0	0.001

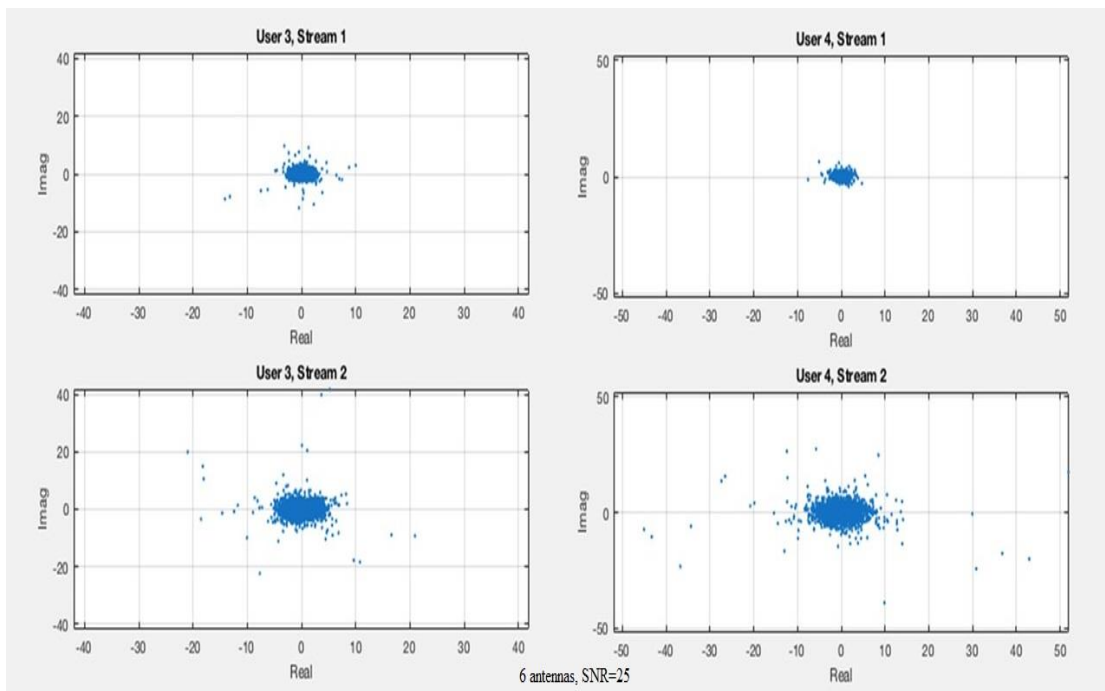
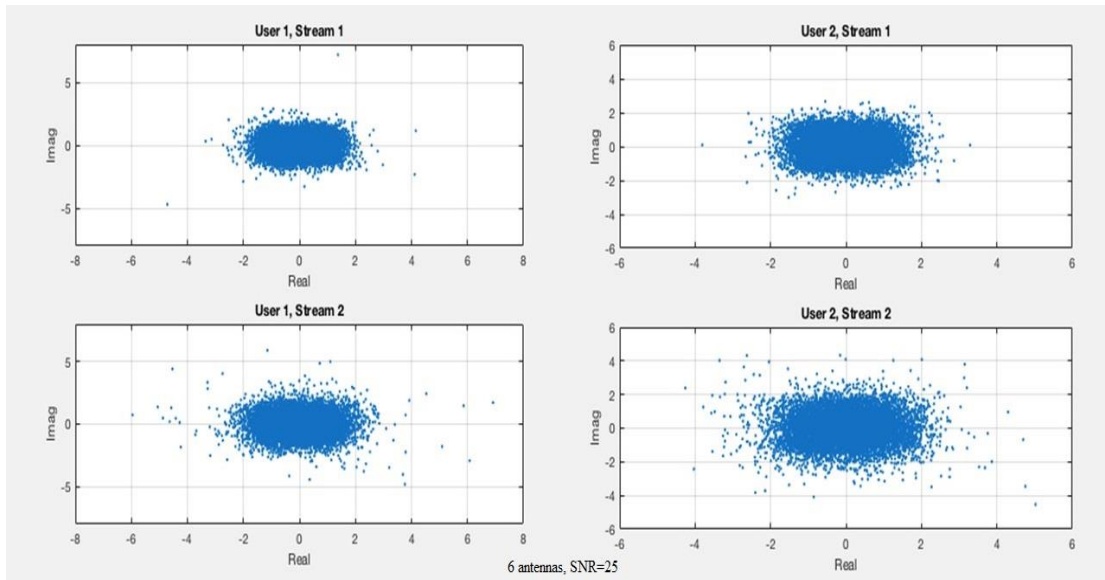

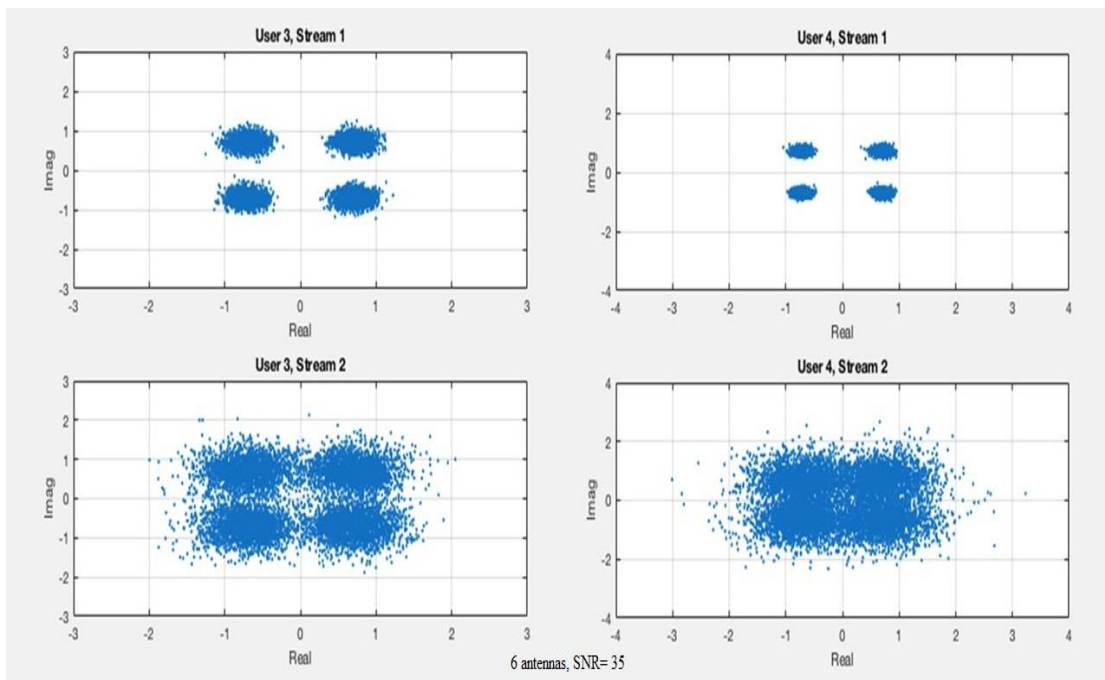
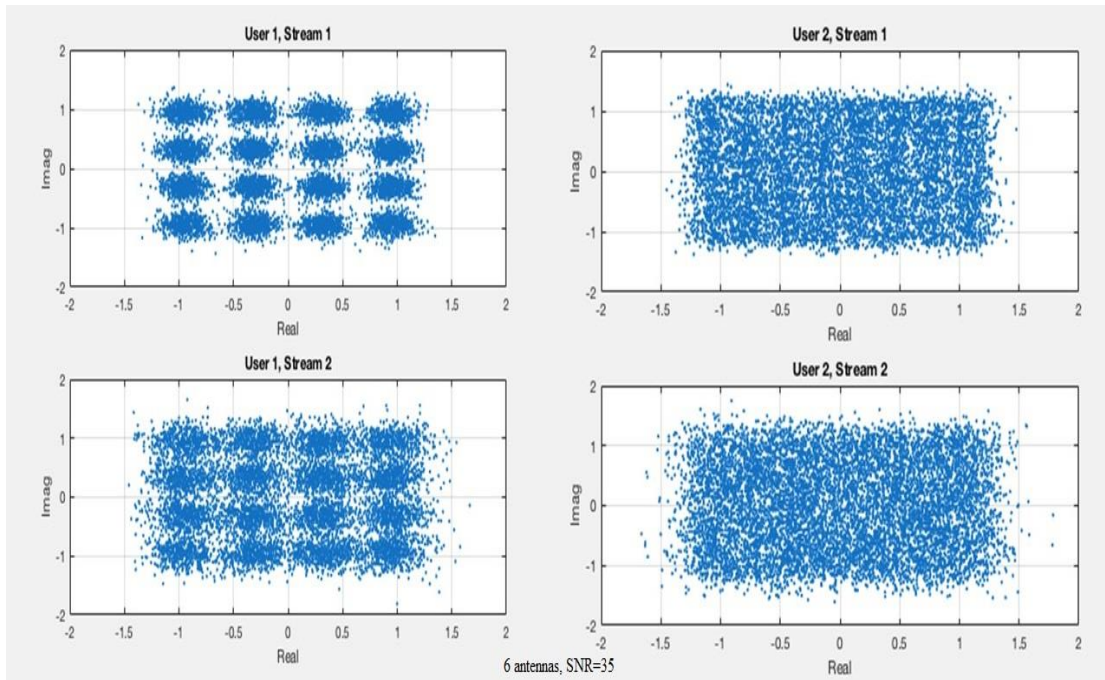

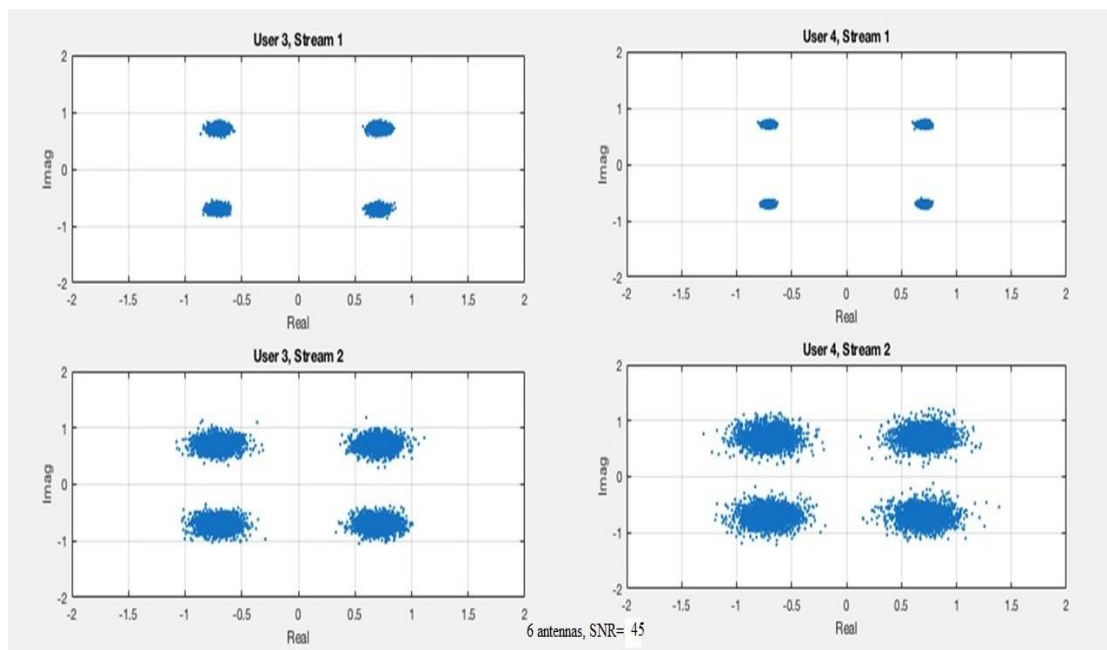
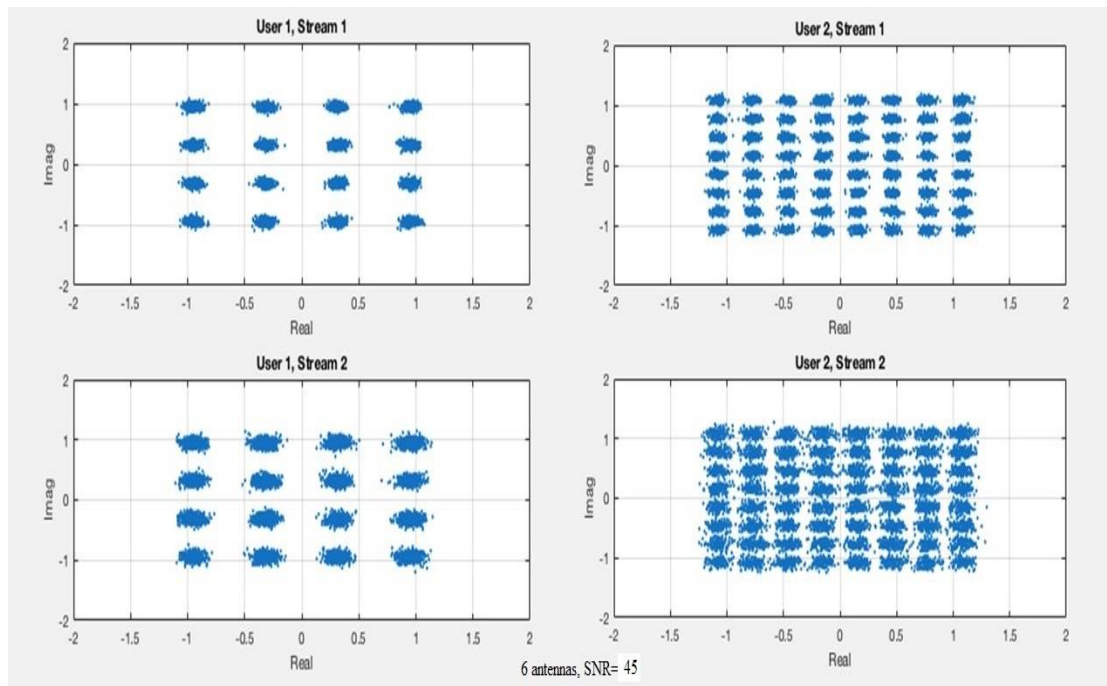

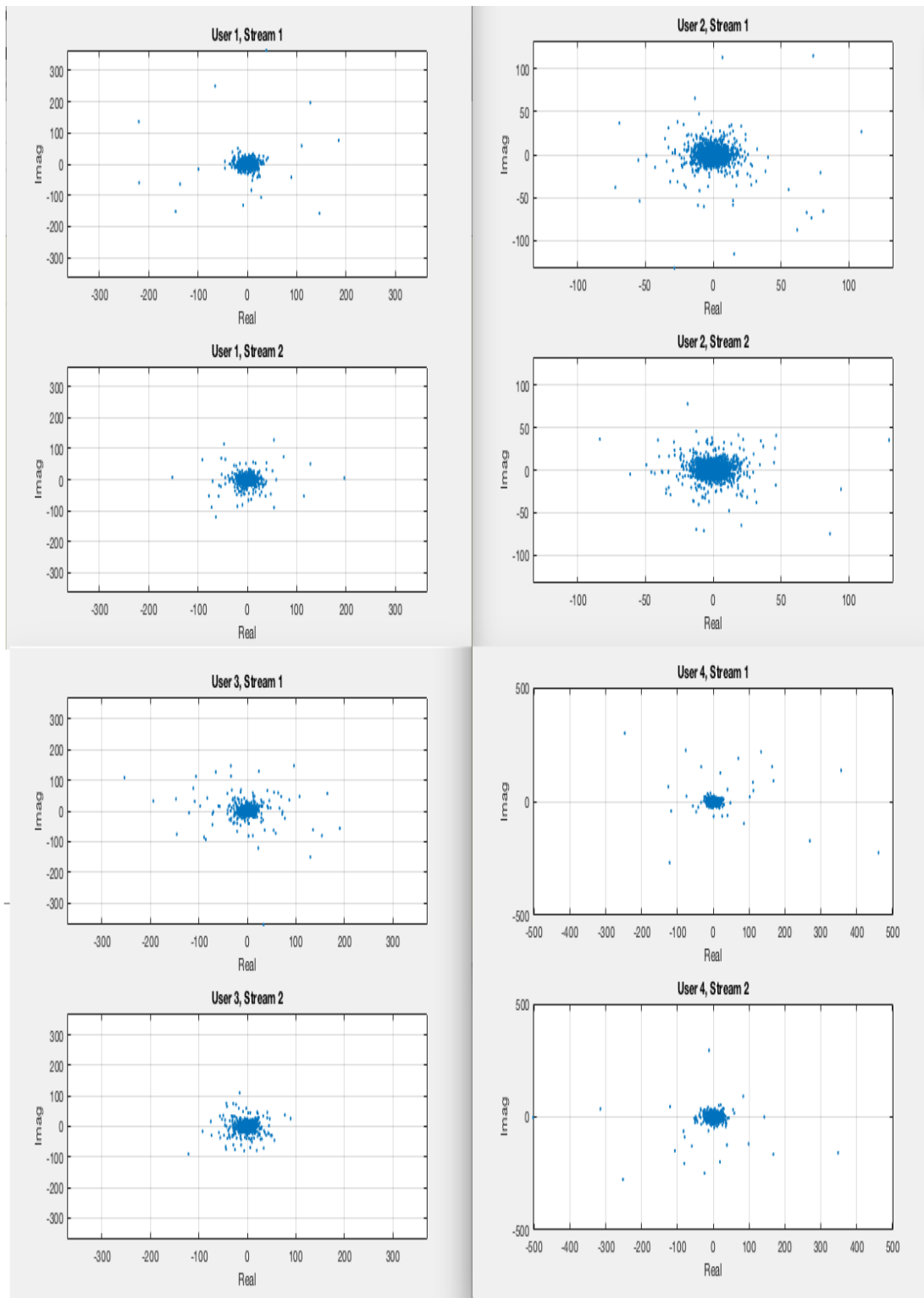

8 antennas SNR = 5

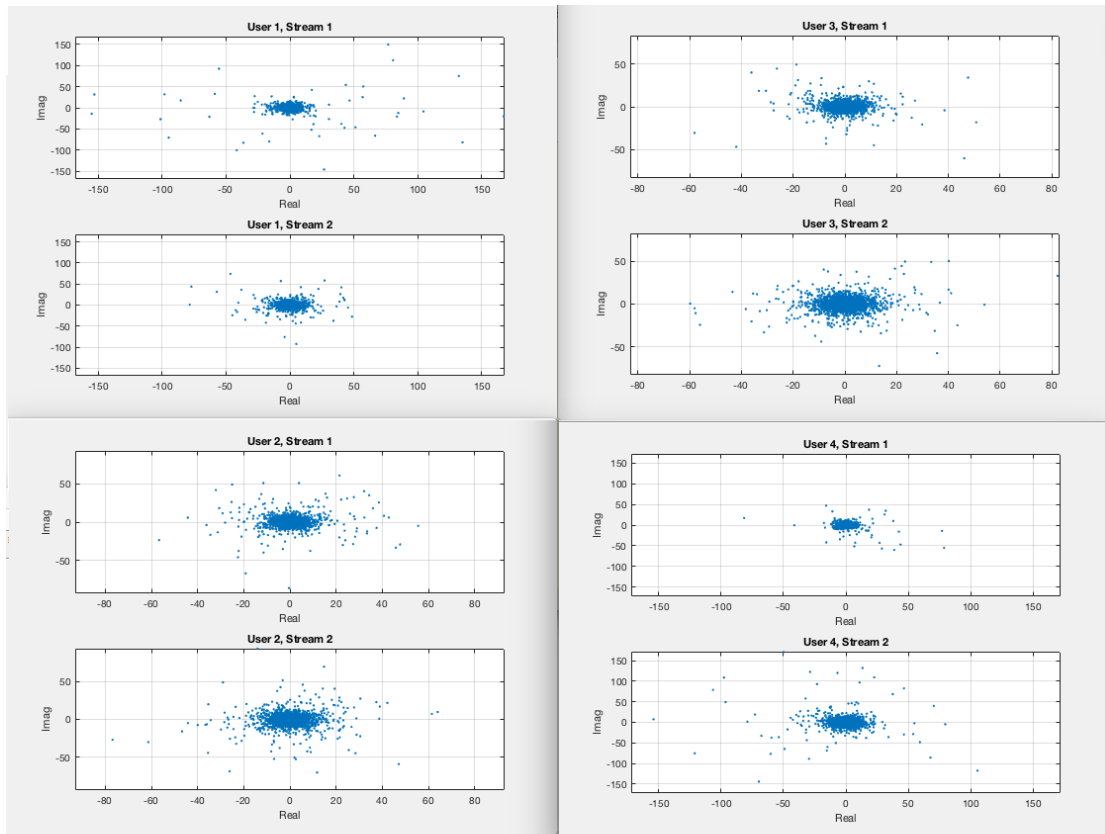

8 antennas SNR = 15

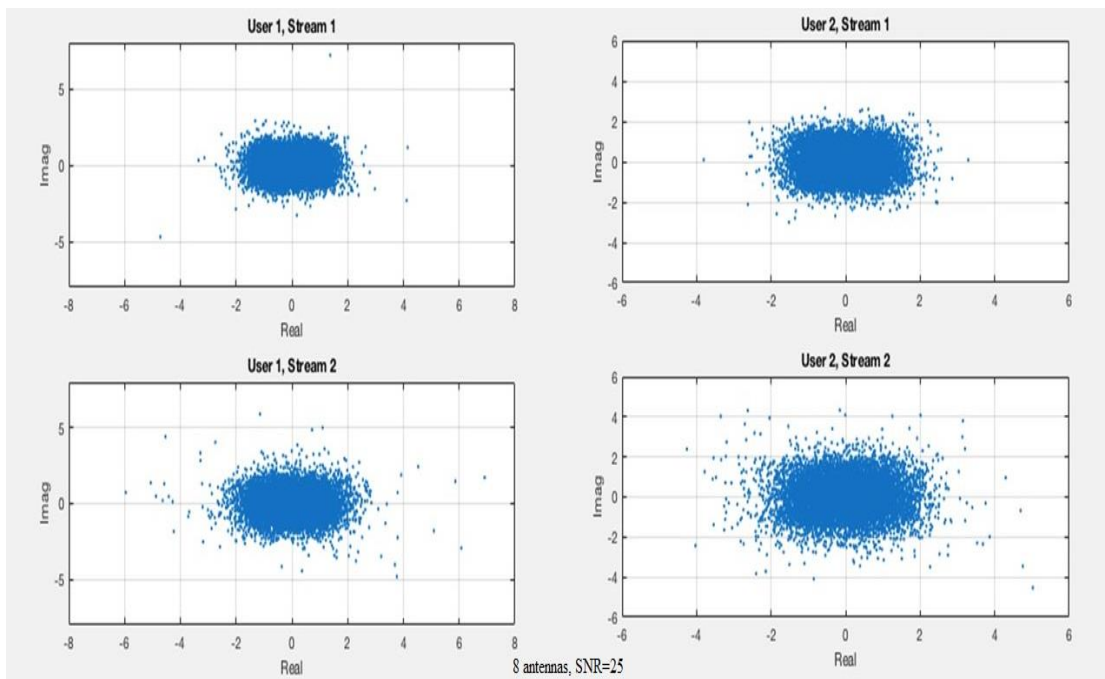

8 antennas, SNR=25

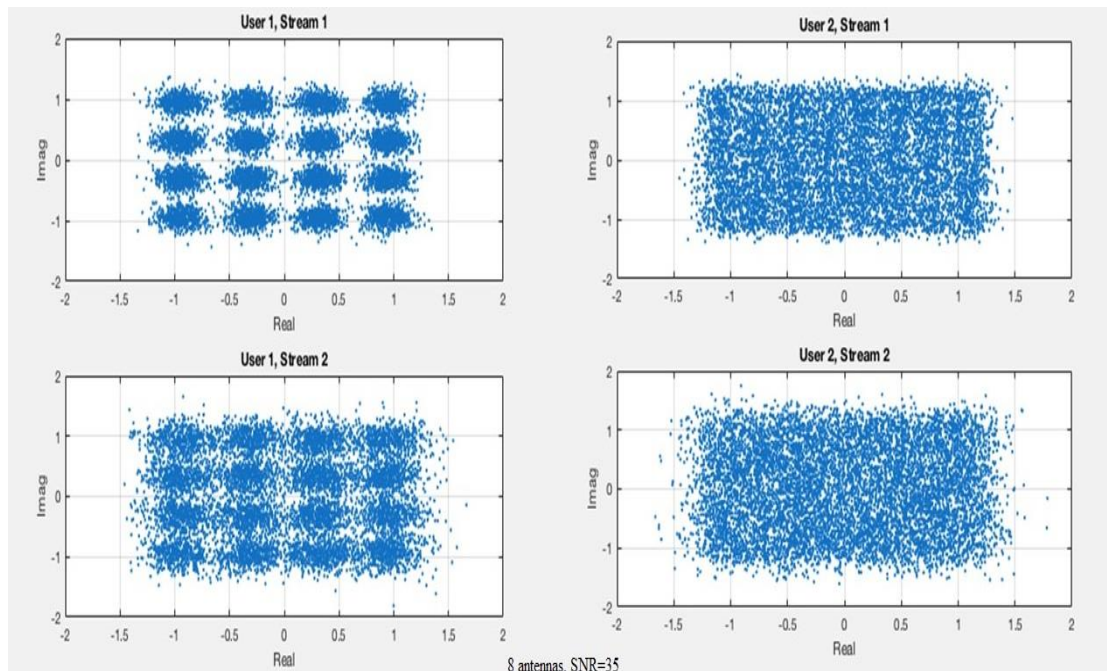
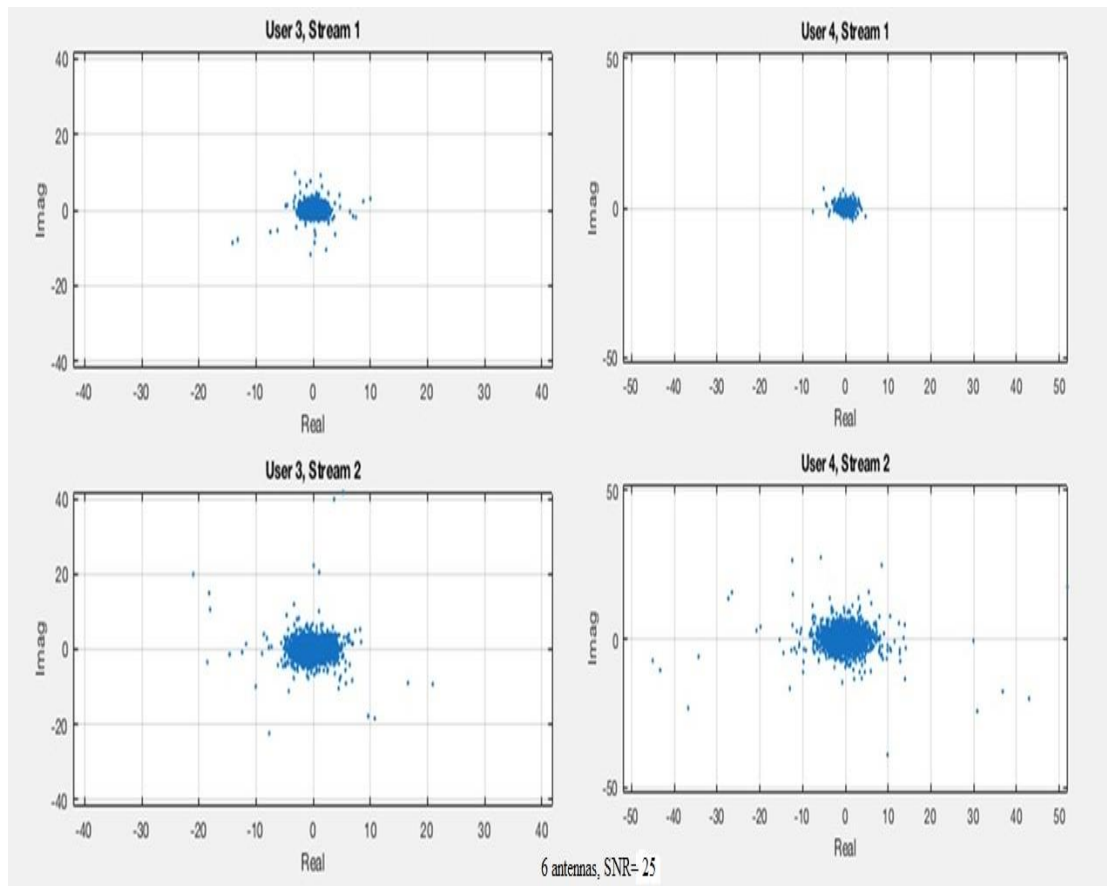

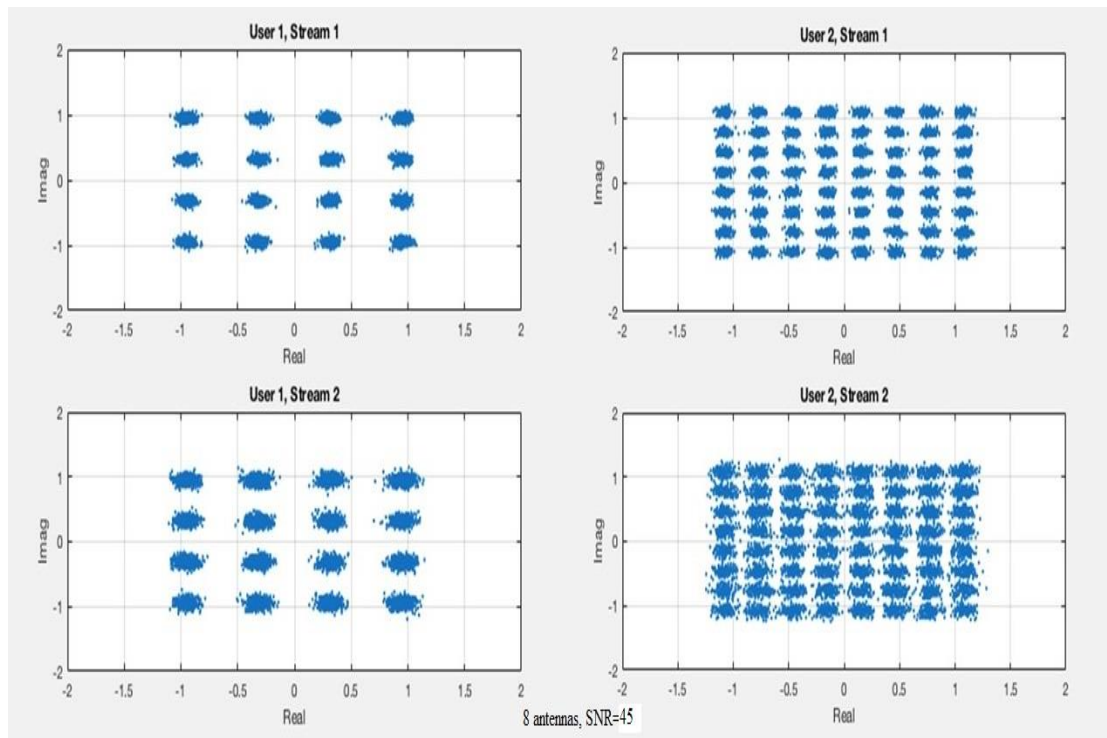
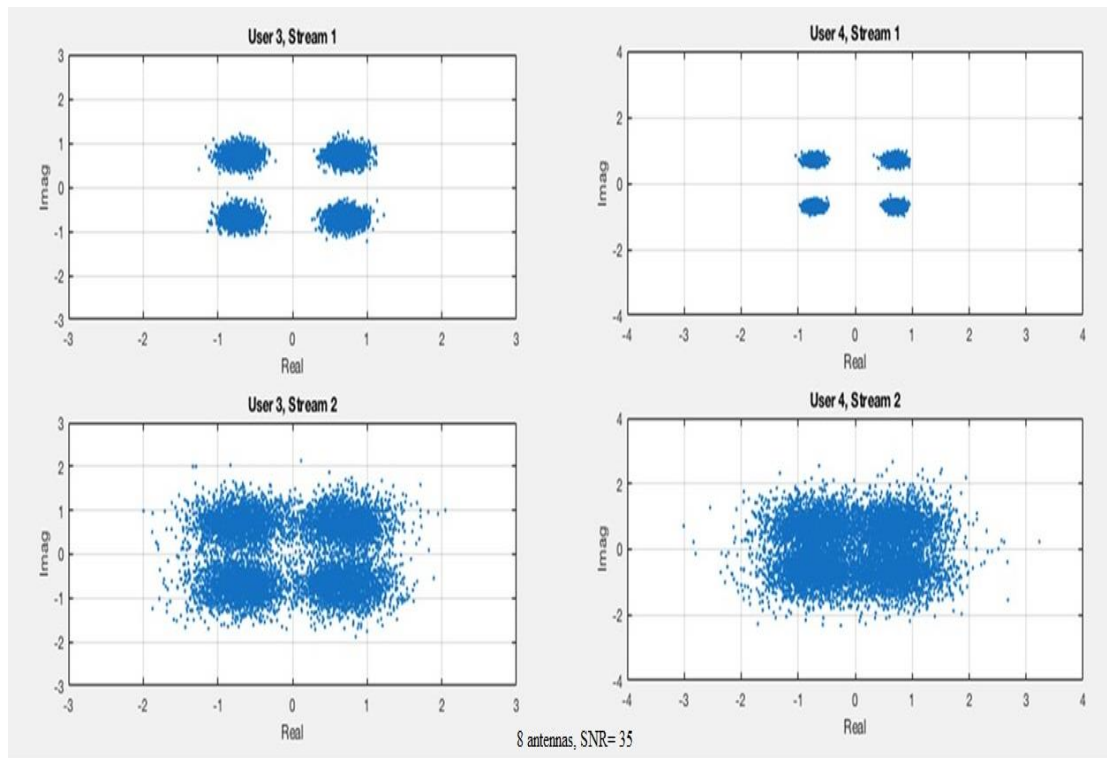

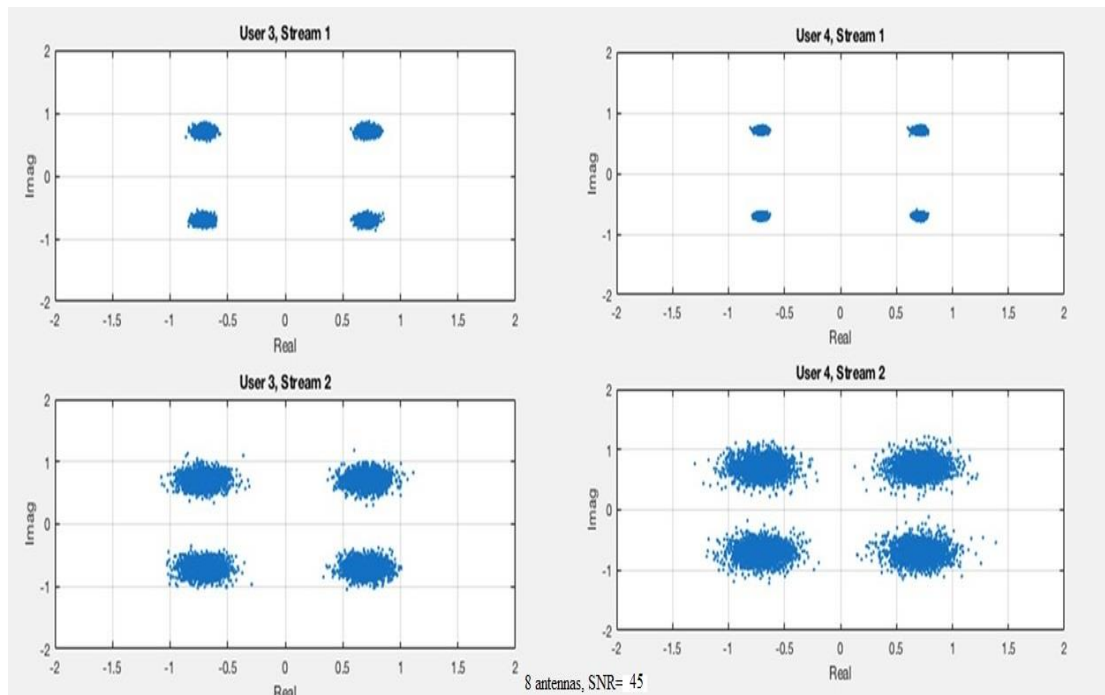

5.1.5 Conclusion

This work studies the physical layer of the under-development new WLAN standard, IEEE 802.11ax. The new standard promises high data rates. This will be mainly achieved by employing more bandwidth, higher orders of modulations, and more MIMO streams. The 11ax is compatible with the 11ac standard. Both of them operate in the same below 6GHz band and use Multiuser MIMO. The above simulations show multi-user transmit configuration, independent per-user channel modeling, and the individual receive processing using the channel inversion precoding techniques. The small number of bit errors, within noise variance, indicate successful data decoding for all streams for each user, despite the variation in EVMs seen in individual streams. The BER performance of different MCS shows that higher orders of modulation require lower noise level (Higher SNR). While these same modulations maintain a low EVM. Higher orders of MIMO systems show better BER performance, although the usage of such systems may require higher SNR values in real applications. Lower noise level, better BER and the result is Higher Throughput. With the spatial streams data transmit faster with lower Bit Error Rate.

In the study of the 11ax/ac performance, only symmetrical MIMO systems were considered, 6×6 and 8×8 . Other combinations can be tested and compared. For example, studying the effect of the number of antennas in the receiver or in the transmitter. The simulations in this thesis covers a wide range of optional features in the 11ac standard. However, more features could be added to include up to 16 spatial streams.

References

- [1] Mathew S. Gast, “802.11ac A Survival Guide” O’Reilly Media Inc., 2013
- [2] Eldad Perahia, Robert Stacey, “Next Generation Wireless LANs, 802.11n and 802.11ac-Second Edition”, Cambridge University Press, 2013
- [3] P. Huang, R. Stacey, R. Yang, Q. Li,(March 2014) “The impact of Preamble Error on MAC System Performance”, 11-14-1420-01-00ax, TGax Submission, (http://www.ieee802.org/11/Reports/tgax_update.htm).
- [4] A. Goldsmith, S. A. Jafar, N. Jindal, and S. Vishwanath, “Capacity limits of MIMO channels,” IEEE J. Selected Areas in Communications (JSAC), vol. 21, no. 5, pp. 684–702, 2003.
- [5] “IEEE standard for information technology–telecommunications and information exchange between systems local and metropolitan area networks–specific requirements part 11: Wireless LAN medium access control (MAC) and physical layer (PHY) specifications,” pp. 1–2793, Mar., 2012.
- [6] “IEEE standard for information technology– telecommunications and information exchange between systems local and metropolitan area networks– specific requirements–part 11: Wireless LAN medium access control (MAC) and physical layer (PHY) specifications–amendment 4: Enhancements for very high throughput for operation in bands below 6 GHz,” pp. 1–425, 2013.
- [7] IEEE 802.11-13/1154r1, “DL-MU-MIMO transmission with unequal Bandwidth”, 2013
- [8] IEEE 802.11-13/1046r2, “Discussion on massive MIMO for HEW”, 2013.
- [9] Li, Bo, et al. ”Survey on OFDMA based MAC protocols for the next generation WLAN.”Wireless Communications and Networking Conference Workshops (WCNCW), 2015 IEEE.IEEE, 2015

- [10] Qu, Qiao, et al. "An OFDMA based concurrent multiuser MAC for upcoming IEEE 802.11ax." Wireless Communications and Networking Conference Workshops (WCNCW), IEEE, 2015
- [11] "IEEE standard for information technology–telecommunications and information exchange between systems local and metropolitan area networks–specific requirements part 11: Wireless LAN medium access control (MAC) and physical layer (PHY) specifications," pp. 1–2793, Mar., 2012.
- [12] IEEE, "E specification 802.11-2007," 2007.
- [13] IEEE 802.11-13/1012, "Dynamic sensitivity control", 2014.
- [14] IEEE 802.11-14/1207, "OBSS reuse mechanism which preserves fairness," 2014
- [15] IEEE 802.11-14/0872, "A protocol framework for dynamic CCA", 2014
- [16] For more information on the channel acquisition procedure, see Chapter 3 of *802.11 Wireless Networks: The Definitive Guide*.
- [17] Borris Bellalta, (July, 2015) "IEEE 802.11ax : High Efficiency WLANs", IEEE Wireless Communications Magazine pp. 38-46.
- [18] IEEE 802.11-15/0132r16, Specification Framework Document.
- [19] IEEE: IEEE 802.11-16/0024r1, Proposed TGax draft specification.
- [20] IEEE 802.11 Task Group AX, "Status of Project IEEE 802.11ax High Efficiency WLAN.
- [21] Eye on 802.11ax: What it is and How to Overcome the Test Challenges it Creates.
- [22] S. Valentin et al., "Integrating Multiuser Dynamic OFDMA Into IEEE 802.11 WLANs-LLC/Mac Extensions and System Performance.
- [23] IEEE 802.11 WLANs, Working Group for WLAN Standards, 2015.
- [24] http://grouper.ieee.org/groups/802/11/Reports/hew_update.htm

- [25] V. P. Mhatre and K. Papagiannaki, "Optimal Design of High Density 802.11 WLANs," in *Proceedings of the ACM CoNEXT Conference*, ser. CoNEXT '06, pp. 8:1–8:12. New York, NY, USA: ACM, 2006. doi: 10.1145/1368436.1368448. ISBN 1-59593-456-1
- [26] J. Zhu, X. Guo, L. Lily Yang, W. Steven Conner, S. Roy, and M. M. Hazra, "Adapting Physical Carrier Sensing to Maximize Spatial Reuse in 802.11 Mesh Networks: Research Articles," *wireless communications and mobile computing*, vol. 4, no. 8, pp.33–946, Dec. 2004. doi: 10.1002/wcm.v4:8
- [27] D. Kim, H. Lee, and D. Hong, "A survey of in-band full-duplex transmission: From the perspective of PHY and MAC layers," *IEEE Communications Surveys and Tutorials*, 2015, In press
- [28] IEEE 802.11-14/1172r2, "Multicast performance in OBSS," 2014
- [29] IEEE 802.11-13/1061r0, "Multicast transmission for HEW," 2013
- [30] IEEE 802.11-14/1207, "OBSS reuse mechanism which preserves fairness", 2014
- [31] I. Jamil, L. Cariou, and J.-F. Helard, "Improving the capacity of future IEEE 802.11 high efficiency WLANs," in *Proc. of IEEE ICT*, 2014, pp. 303–307
- [32] A. E. Xhafa, A. Batra, and A. Zaks, "On the coexistence of overlapping BSSs in WLANs," in *Proc. IEEE VTC*, 2007, pp. 189–193
- [33] I. 802.11-14/0889, "Performance gains from CCA optimization," 2014
- [34] IEEE 802.11-14/0846, "CCA study in residential scenario," 2014
- [35] T. Nakahira, K. Ishihara, Y. Asai, Y. Takatori, R. Kudo, and M. Mizoguchi, "Centralized control of carrier sense threshold and channel bandwidth in high-density WLANs," in *Proc. IEEE APMC*, 2014, pp. 570–572
- [36] <https://www.mathworks.com/help/wlan/examples/802-11ac-multi-user-mimo-precoding.html#d119e655>
- [36] <https://www.mathworks.com/help/releases/R2016b/wlan/examples/802-11ac-multi-user-mimo-precoding.html>

Appendix A (8 antennas)

```

s = rng(21); % Set RNG seed for repeatability

% Transmission parameters
chanBW = 'CBW160'; % Channel bandwidth
numUsers = 4; % Number of users
numSTSVec = [1 1 1 1]; % Number of streams per user
userPos = [0 1 2 3]; % User positions
mcsVec = [9 9 9 9]; % MCS per user: 16QAM, 64QAM,
QPSK
apepVec = [3024 8192 2464 8192]; % Payload per user, in bytes
chCodingVec = {'BCC', 'BCC', 'BCC', 'BCC'}; % Channel coding per user

% Channel and receiver parameters
chanMdl = 'Model-A'; % TGac fading channel model
precodingType = 'ZF'; % Precoding type
snr = 35; % SNR in dB
eqMethod = 'ZF'; % Equalization method

% Create the multi-user VHT format configuration object
numTx = sum(numSTSVec);
cfgVHTMU = wlanVHTConfig('ChannelBandwidth', chanBW, ...
    'NumUsers', numUsers, ...
    'NumTransmitAntennas', numTx, ...
    'GroupID', 1, ...
    'NumSpaceTimeStreams', numSTSVec, ...
    'UserPositions', userPos, ...
    'MCS', mcsVec, ...
    'APEPLength', apepVec, ...
    'ChannelCoding', chCodingVec);
VHT sounding (NDP) configuration, for same number of streams
cfgVHTNDP = wlanVHTConfig('ChannelBandwidth', chanBW, ...
    'NumUsers', 1, ...
    'NumTransmitAntennas', numTx, ...
    'GroupID', 0, ...
    'NumSpaceTimeStreams', sum(numSTSVec), ...
    'MCS', 0, ...
    'APEPLength', 0);

% Generate the null data packet, with no data
txNDPSig = wlanWaveformGenerator([], cfgVHTNDP);

% Create threehe
chanSeeds = [1111 2222 3333 4444]; % chosen for a maximum of 4 users
uIndex = [10 5 2 1]; % chosen for a maximum of 4 users
chanDelay = zeros(numUsers, 1);
for uIdx = 1:numUsers
    TGAC{uIdx} = wlanTGacChannel(...
        'ChannelBandwidth', cfgVHTMU.ChannelBandwidth, ...
        'DelayProfile', chanMdl, ...
        'UserIndex', uIndex(uIdx), ...
        'NumTransmitAntennas', numTx, ...
        'NumReceiveAntennas', numSTSVec(uIdx), ...
        'RandomStream', 'mt19937ar with seed', ...
        'Seed', chanSeeds(uIdx), ...
        'SampleRate', helperSampleRate(chanBW));
    chanInfo = info(TGAC{uIdx});
    chanDelay(uIdx) = chanInfo.ChannelFilterDelay;
end

```

```

% Sound the independent channels per user for all transmit streams

rxNDPSig = cell(numUsers, 1);
for uIdx = 1:numUsers
    % Append zeroes to allow for channel filter delay
    rxNDPSig{uIdx} = TGAC{uIdx}([txNDPSig; zeros(10, numTx)]);
end

%% Channel State Information Feedback
mat = cell(numUsers,1);
for uIdx = 1:numUsers
    % Add WGN per receiver
    rxNDPNsig = awgn(rxNDPSig{uIdx}, snr);

    % Compute the feedback matrix based on received signal per user
    mat{uIdx} = vhtCSIFeedback(rxNDPNsig(chanDelay(uIdx)+1:end,:), ...
        cfgVHTNDP, uIdx, numSTSVec);
end

% Pack the per user CSI into a matrix
numST = length(mat{1}); % Number of subcarriers
steeringMatrix = zeros(numST, sum(numSTSVec), sum(numSTSVec));
% Nst-by-Nt-by-Nsts
for uIdx = 1:numUsers
    stsIdx = sum(numSTSVec(1:uIdx-1))+(1:numSTSVec(uIdx));
    steeringMatrix(:, :, stsIdx) = mat{uIdx}; % Nst-by-Nt-by-Nsts
end

if strcmp(precodingType, 'ZF')
    % Zero-forcing precoding solution (channel inverse)
    for i = 1:numST
        h = squeeze(steeringMatrix(i, :, :));
        steeringMatrix(i, :, :) = h/(h'*h);
    end
else
    % MMSE precoding solution (regularized channel inverse)
    delta = (numTx/(10^(snr/10))) * eye(numTx);
    for i = 1:numST
        h = squeeze(steeringMatrix(i, :, :));
        steeringMatrix(i, :, :) = h/(h'*h + delta);
    end
end

% Set the spatial mapping based on the steering matrix
cfgVHTMU.SpatialMapping = 'Custom';
cfgVHTMU.SpatialMappingMatrix = permute(steeringMatrix,[1 3 2]);

% Create data sequences, one for each user
d = cell(numUsers, 1); dp = d;
for uIdx = 1:numUsers
    d{uIdx} = randi([0 1], cfgVHTMU.APEPLength(uIdx)*8, 1, 'int8');

    % Zero-pad to PSDU length per user
    dp{uIdx} = [d{uIdx}; ...
        zeros(cfgVHTMU.PSDULength(uIdx)*8-length(d{uIdx}), 1, 'int8')];
end

% Generate the multi-user VHT waveform
txSig = wlanWaveformGenerator(dp, cfgVHTMU);

```

```

% Transmit through per-user fading channel
rxSig = cell(numUsers, 1);
for uIdx = 1:numUsers
    % Append zeroes to allow for channel filter delay
    rxSig{uIdx} = TGAC{uIdx}([txSig; zeros(10, numTx)]);
end

% Configure recovery object
cfgRec = wlanRecoveryConfig('EqualizationMethod', eqMethod, ...
    'PilotPhaseTracking', 'None');

% Get parameters from configuration, assumed known at receiver
numSTSVec = cfgVHTMU.NumSpaceTimeStreams;
ind = wlanFieldIndices(cfgVHTMU);

% Single-user receivers recover payload bits
rxDataBits = cell(numUsers, 1);
for uIdx = 1:numUsers
    % Add WGN per receiver
    rxNSig = awgn(rxSig{uIdx}, snr);
    rxNSig = rxNSig(chanDelay(uIdx)+1:end, :);

    % User space-time streams
    stsU = numSTSVec(uIdx);

    % Estimate noise power in VHT fields
    lltf = rxNSig(ind.LLTF(1):ind.LLTF(2),:);
    demodLLTF = wlanLLTFDemodulate(lltf, chanBW);
    nVar = helperNoiseEstimate(demodLLTF, chanBW, stsU);

    % Perform channel estimation based on VHT-LTF
    rxVHTLTF = rxNSig(ind.VHTLTF(1):ind.VHTLTF(2),:);
    demodVHTLTF = wlanVHTLTFDemodulate(rxVHTLTF, chanBW, numSTSVec);
    chanEst = wlanVHTLTFChannelEstimate(demodVHTLTF, chanBW, numSTSVec);

    % Recover information bits in VHT Data field
    rxVHTData = rxNSig(ind.VHTData(1):ind.VHTData(2),:);
    [rxDataBits{uIdx}, ~, eqsym] = wlanVHTDataRecover(rxVHTData, ...
        chanEst, nVar, cfgVHTMU, uIdx, cfgRec);

    % Plot equalized symbols for all streams (Nss) per user
    h = figure;
    h.Name = ['User ' num2str(uIdx) ' Equalized Symbols'];
    scaler = ceil(max(abs([real(eqsym(:)); imag(eqsym(:))])));
    for i = 1:stsU
        if stsU>2
            subplot(2, 2, i);
        else
            subplot(stsU, 1, i);
        end
        plot(reshape(eqsym(:, :, i), [], 1), '.'); grid on;
        xlim([-scaler scaler]);
        ylim([-scaler scaler]);
        title(['User ' num2str(uIdx) ', Stream ' num2str(i)]);
        xlabel('Real'); ylabel('Imag');
    end
end
end

```

```
% Compare recovered bits against per-user APEPLength information bits
numerr = inf(1, numUsers);
for uIdx = 1:numUsers
    idx = (1:cfgVHTMU.APEPLength(uIdx)*8).';
    numerr(uIdx) = biterr(d{uIdx}(idx), rxDataBits{uIdx}(idx));
    disp(['Bit Errors for User ' num2str(uIdx) ': ' ...
        num2str(numerr(uIdx))]);
end

rng(s); % Restore RNG state
```

Appendix B (6 antennas)

```

s = rng(21); % Set RNG seed for repeatability

% Transmission parameters
chanBW = 'CBW80'; % Channel bandwidth
numUsers = 3; % Number of users
numSTSVec = [3 1 4]; % Number of streams per user
userPos = [0 1 2]; % User positions
mcsVec = [4 6 2]; % MCS per user: 16QAM, 64QAM, QPSK
apepVec = [3024 8192 2464]; % Payload per user, in bytes
chCodingVec = {'BCC', 'LDPC', 'LDPC'}; % Channel coding per user

% Channel and receiver parameters
chanMdl = 'Model-A'; % TGac fading channel model
precodingType = 'ZF'; % Precoding type
snr = 35; % SNR in dB
eqMethod = 'ZF'; % Equalization method

% Create the multi-user VHT format configuration object
numTx = sum(numSTSVec);
cfgVHTMU = wlanVHTConfig('ChannelBandwidth', chanBW,...
    'NumUsers', numUsers, ...
    'NumTransmitAntennas', numTx, ...
    'GroupID', 2, ...
    'NumSpaceTimeStreams', numSTSVec,...
    'UserPositions', userPos, ...
    'MCS', mcsVec, ...
    'APEPLength', apepVec, ...
    'ChannelCoding', chCodingVec);
% VHT sounding (NDP) configuration, for same number of streams
cfgVHTNDP = wlanVHTConfig('ChannelBandwidth', chanBW,...
    'NumUsers', 1, ...
    'NumTransmitAntennas', numTx, ...
    'GroupID', 0, ...
    'NumSpaceTimeStreams', sum(numSTSVec),...
    'MCS', 0, ...
    'APEPLength', 0);
% Generate the null data packet, with no data
txNDPSig = wlanWaveformGenerator([], cfgVHTNDP);
% Create three independent channels with respective receive antennas
TGAC = cell(numUsers, 1);
chanSeeds = [1111 2222 3333 4444]; % chosen for a maximum of 4 users
uIndex = [10 5 2 1]; % chosen for a maximum of 4 users
chanDelay = zeros(numUsers, 1);
for uIdx = 1:numUsers
    TGAC{uIdx} = wlanTGacChannel(...
        'ChannelBandwidth', cfgVHTMU.ChannelBandwidth,...
        'DelayProfile', chanMdl, ...
        'UserIndex', uIndex(uIdx), ...
        'NumTransmitAntennas', numTx, ...
        'NumReceiveAntennas', numSTSVec(uIdx), ...
        'RandomStream', 'mt19937ar with seed', ...
        'Seed', chanSeeds(uIdx),...
        'SampleRate', helperSampleRate(chanBW));
    chanInfo = info(TGAC{uIdx});

```



```

        chanDelay(uIdx) = chanInfo.ChannelFilterDelay;
    end
    mat = cell(numUsers,1);
    for uIdx = 1:numUsers
        % Add WGN per receiver
        rxNDPNSig = awgn(rxNDPSig{uIdx}, snr);

        % Compute the feedback matrix based on received signal per user
        mat{uIdx} = vhtCSIFeedback(rxNDPNSig(chanDelay(uIdx)+1:end,:), ...
            cfgVHTNDP, uIdx, numSTSVec);
    end
    % Pack the per user CSI into a matrix
    numST = length(mat{1}); % Number of subcarriers
    steeringMatrix = zeros(numST, sum(numSTSVec), sum(numSTSVec));
    % Nst-by-Nt-by-Nsts
    for uIdx = 1:numUsers
        stsIdx = sum(numSTSVec(1:uIdx-1))+(1:numSTSVec(uIdx));
        steeringMatrix(:, :, stsIdx) = mat{uIdx}; % Nst-by-Nt-by-Nsts
    end

    if strcmp(precodingType, 'ZF')
        % Zero-forcing precoding solution (channel inverse)
        for i = 1:numST
            h = squeeze(steeringMatrix(i, :, :));
            steeringMatrix(i, :, :) = h/(h'*h);
        end
    else
        % MMSE precoding solution (regularized channel inverse)
        delta = (numTx/(10^(snr/10))) * eye(numTx);
        for i = 1:numST
            h = squeeze(steeringMatrix(i, :, :));
            steeringMatrix(i, :, :) = h/(h'*h + delta);
        end
    end
end

% Set the spatial mapping based on the steering matrix
cfgVHTMU.SpatialMapping = 'Custom';
cfgVHTMU.SpatialMappingMatrix = permute(steeringMatrix,[1 3 2]);

% Create data sequences, one for each user
d = cell(numUsers, 1); dp = d;
for uIdx = 1:numUsers
    d{uIdx} = randi([0 1], cfgVHTMU.APEPLength(uIdx)*8, 1, 'int8');

    % Zero-pad to PSDU length per user
    dp{uIdx} = [d{uIdx}; ...
        zeros(cfgVHTMU.PSDULength(uIdx)*8-length(d{uIdx}), 1, 'int8')];
end

% Generate the multi-user VHT waveform
txSig = wlanWaveformGenerator(dp, cfgVHTMU);

% Transmit through per-user fading channel
rxSig = cell(numUsers, 1);
for uIdx = 1:numUsers
    % Append zeroes to allow for channel filter delay
    rxSig{uIdx} = TGAC{uIdx}([txSig; zeros(10, numTx)]);
end
end
% Configure recovery object

```

```

cfgRec = wlanRecoveryConfig('EqualizationMethod', eqMethod, ...
    'PilotPhaseTracking', 'None');

% Get parameters from configuration, assumed known at receiver
numSTSVec = cfgVHTMU.NumSpaceTimeStreams;
ind = wlanFieldIndices(cfgVHTMU);

% Single-user receivers recover payload bits
rxDataBits = cell(numUsers, 1);
for uIdx = 1:numUsers
    % Add WGN per receiver
    rxNSig = awgn(rxSig{uIdx}, snr);
    rxNSig = rxNSig(chanDelay(uIdx)+1:end, :);

    % User space-time streams
    stsU = numSTSVec(uIdx);

    % Estimate noise power in VHT fields
    lltf = rxNSig(ind.LLTF(1):ind.LLTF(2),:);
    demodLLTF = wlanLLTFDemodulate(lltf, chanBW);
    nVar = helperNoiseEstimate(demodLLTF, chanBW, stsU);

    % Perform channel estimation based on VHT-LTF
    rxVHTLTF = rxNSig(ind.VHTLTF(1):ind.VHTLTF(2),:);
    demodVHTLTF = wlanVHTLTFDemodulate(rxVHTLTF, chanBW, numSTSVec);
    chanEst = wlanVHTLTFChannelEstimate(demodVHTLTF, chanBW, numSTSVec);

    % Recover information bits in VHT Data field
    rxVHTData = rxNSig(ind.VHTData(1):ind.VHTData(2),:);
    [rxDataBits{uIdx}, ~, eqsym] = wlanVHTDataRecover(rxVHTData, ...
        chanEst, nVar, cfgVHTMU, uIdx, cfgRec);

    % Plot equalized symbols for all streams (Nss) per user
    h = figure;
    h.Name = ['User ' num2str(uIdx) ' Equalized Symbols'];
    scaler = ceil(max(abs([real(eqsym(:)); imag(eqsym(:))])));
    for i = 1:stsU
        if stsU>2
            subplot(2, 2, i);
        else
            subplot(stsU, 1, i);
        end
        plot(reshape(eqsym(:, :, i), [], 1), '.'); grid on;
        xlim([-scaler scaler]);
        ylim([-scaler scaler]);
        title(['User ' num2str(uIdx) ', Stream ' num2str(i)]);
        xlabel('Real'); ylabel('Imag');
    end
end
% Compare recovered bits against per-user APEPLength information bits
numerr = inf(1, numUsers);
for uIdx = 1:numUsers
    idx = (1:cfgVHTMU.APEPLength(uIdx)*8).';
    numerr(uIdx) = biterr(d{uIdx}(idx), rxDataBits{uIdx}(idx));
    disp(['Bit Errors for User ' num2str(uIdx) ': ' ...
        num2str(numerr(uIdx))]);
end

rng(s); % Restore RNG state

```